

Catalogue Cum Price List



KALYANI
INDUSTRIES



KALYANI
INDUSTRIES



PLUGS

SOCKETS

CONNECTORS

A / C BOX

PUSH BUTTONS



ROTARY SWITCHES

SELECTOR ACTUATORS

Ref : JAI / GC / 2017

Date : 18.08.2021

Dear Sir,

At the outset, we thank you all for patronizing our products. As you are aware, our **JAI BALAJI** products are the **ONLY PRODUCTS** available in India with   &  Markings and **IP-67** Protection. We are also an **ISO 9001 : 2015** Certified company offering **QUALITY PLUS** Products at **MOST COMPETITIVE PRICE**. **JAI BALAJI** Products are manufactured making use of **UL Listed V2 Flame Retardant Grade 960°** Glow Wire Tested Anti corrosive Anti-Acid unbreakable **Engineering Plastic** and are fully insulated. Our wide range of products are **Illuminated Push Buttons, Pilot lights, Push Button Stations (Plastic & Metal) LED Electronic Module Indicating lights (16.5 mm & 22.5 mm dia) Electronic signal Tower lights (LED & BULB) Electronic Proximity Sensors (Photo Sensors, Diffuse, Thro' Beam, Colour mark, Inductive & Capacitive) Electronic Timer Din Rail (Analog & Digital) Electronic Digital Counter / Timer, Digital Meters AC / DC Voltmeter, Ammeter, Digital Panel Meters, Frequency Meters, Variety of Limit Switches, like BC-9, BC-9T, JW Micro Adjustable, CEE EM 45, Precision, Miniature Snap Action, Mini Limit Switches, Heavy Duty Limit Switches JB - 2700, Extra Heavy Duty JC-1125 Limit Switches, Explosion Proof EPHA Limit Switches, Foot Switches, Engineering Plastic Industrial Plug & Sockets, and Connectors Cam Operated Rotary Switches, variety of different sizes of Junction Boxes (Engineering Plastic & Metal) and Telescopic Brushes, Pullcord, Beltway, Zero speed switch & Rocker switch. Distribution Boxes, Pendent Pushbutton stations, CEE EM 45 Mini Limit Switch, Bus bar Indicator & Reed Magnetic Switch**

DEALERS ENQUIRIES ARE SOLICITED

This supersedes all previous Price Lists, Prices are subject to change without prior notice, Prices at the time of supply will be applicable.

Your continued patronage and kind co-operation will be very much appreciated.

Thanking you and assuring you of our best services always.

Yours faithfully,



CHANAKYACHANDRAMOHAN

Encl : as above.

New No. 107, Sidco Industrial Estate

Post Box No. 27, Ambattur,

Chennai - 600 098. India

Phone : 0091 - 44 - 2625 1279

0091 - 44 - 2625 4469

0091 - 44 - 2625 4470

0091 - 44 - 2625 7174

0091 - 44 - 2625 7859

Fax : 0091 - 44 - 2625 5038

E-mail : dchandramohan@jaibalaji.firm.in



S.No.	List of Panel Accessories	Page No
1	ISO Certificate	1
2	ISI Certificate	2-7
3	CSA Certificate	8-10
4	CE Certificate	11-12
5	Engineering Plastic Plug & Socket	13-16
6	Cam Operated Rotary Switch	17-22
7	Push button non illuminated actuators	23
8	Push button key selector	23-24
9	Push button illuminated actuators pilot light & spares	25-28
10	Engg Plastic Push button station	29
11	Plastic pendant push button station	30
12	AI Push button station with Actuator	31
13	AI pendant push button station with Actuator	31
14	AI Push button station &Pendent	32
15	Engg Plastic Junction & Distribution box	33-37
16	Telescopic brush plug	38

CERTIFICATE

The Certification Body
of TÜV SÜD South Asia Private Limited

certifies that



**Design, Manufacture and Supply of
Electromechanical, Electronic Controlling, Signalling Devices and
Switchgears for Engineering and Industrial Automation**



Rahul Kale

Head of Certification Body
of TÜV SÜD South Asia Private Limited, **Mumbai**
Member of TÜV SÜD Group





இந்திய தர நிர்ணய அமைவனம்

भारतीय मानक ब्यूरो
BUREAU OF INDIAN STANDARDS

दक्षिणी क्षेत्रीय कार्यालय

: पोस्ट बॉक्स नं. 8290

सी. आई. टी. फोरम, चौथा क्रॉस रोड,

तरामनी, चेन्नै - 600 113.

Southern Regional Office : Post Box No. 8290

CIT Campus, IV Cross Road,

Taramani, Chennai - 600 113.

ANNEXURE TO ENDORSEMENT NO.16 DATED

20030206

1) LIMIT SWITCHES

RATED OPERATIONAL VOLTAGE	:	415V
RATED THERMAL CURRENT	:	10A
OPERATIONAL CURRENT	:	1.5A(AC)
RATED IMPULSE VOLTAGE	:	1.5KV AC
INSULATION VOLTAGE	:	600V
POLLUTION DEGREE	:	'2'
IP CODE	:	IP 67
UTILISATION CATEGORY	:	AC 15/DC 13
CONDITIONAL SHORT CIRCUIT CURRENT	:	100A
DESIGNATION	:	A600/R300
CONTACT ELEMENT	:	TYPE : ZA
MECHANICAL DUTY CLASS	:	3
FREQUENCY OF OPERATIONAL CYCLES FOR ELECTRICAL DURABILITY	:	300/HOUR

2) ROTARY SWITCHES:

UTILISATION CATEGORY	:	AC15
RATED INSULATION VOLTAGE	:	600V AC
RATED IMPULSE VOLTAGE	:	1.5KV AC
RATED OPERATIONAL VOLTAGE	:	415V AC,
RATED FREQUENCY	:	50Hz
CORRESPONDING OPERATIONAL CURRENT	:	1.8A, 2A, 4A, 6A, 8A, 10A
CORRESPONDING THERMAL CURRENT	:	7.5A, 12.5A, 20A, 32A, 40A, 80A
POLLUTION DEGREE/CASE	:	3/CASE A
CLASS OF MECHANICAL DURABILITY	:	3
MATERIAL GROUP	:	III a

3) PUSH BUTTON SWITCH

UTILISATION CATEGORY	:	AC15
RATED INSULATION VOLTAGE	:	600V
RATED IMPULSE VOLTAGE	:	1.5KV AC
RATED OPERATIONAL VOLTAGE	:	415V AC, 50Hz
RATED OPERATIONAL CURRENT	:	1.8A
RATED THERMAL CURRENT	:	10A
POLLUTION DEGREE/CASE	:	3/CASE A
CLASS OF MECHANICAL DURABILITY	:	3
DESIGNATION	:	A600/R300

DIRECTOR & HEAD (MARKS II)
BIS, CHENNAI



இந்திய தர நிர்ணய அமைவனம்
भारतीय मानक ब्यूरो
BUREAU OF INDIAN STANDARDS

दक्षिणी क्षेत्रीय कार्यालय

: पोस्ट बॉक्स नं. 8290

सी. आई. टी. फोरम, चौथा क्रॉस रोड,
तरामणी, चेन्नै - 600 113.

Southern Regional Office : Post Box No. 8290

CIT Campus, IV Cross Road,
Taramani, Chennai - 600 113.

ANNEXURE TO ENDORSEMENT NO. 16 DATED 20030266

4) AC INDICATOR LIGHTS (BULB)

Rated operational voltage	24, 48, 110, 230 V AC
Rated voltage of light	24, 48, 110, 230 V AC
Rated voltage of lamp	24, 48, 130, 130 V AC
Rated power	2.0, 2.0, 2.6, 2.6 Watts Max
Rated thermal power for mounting on metal plate	2.6, 2.6, 2.6, 2.6 Watts Max
Rated thermal power for mounting on enclosure	2.6, 2.6, 2.6, 2.6 Watts Max
Colour	Yellow, red, amber, blue, green, black, white, clear (for type and designation and colour, please see the catalogue enclosed)
Fixing hole diameter	22.5 mm, 22.5 mm, 22.5 mm, 22.5 mm
Means of connection	Single pin type small miniature with baynet cap holder
Nature of current applied and its frequency	AC 50 cycles
Type of lamp socket	Small miniature baynet cap holder with Nylon 66 (Grade 30) protective cover

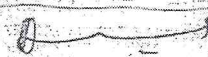
DIRECTOR & HEAD (MARKS II)
BIS, CHENNAI

PAGE 2 OF 6



38
இந்திய தர நிர்ணய அமைவனம்
भारतीय मानक ब्यूरो
BUREAU OF INDIAN STANDARDS

दक्षिणी क्षेत्रीय कार्यालय

: पोस्ट बॉक्स नं. 8290

सी. आई. टी. फौजद, चौथा क्रॉस रोड,

तरावणी, चेन्नै - 600 113.

Southern Regional Office : Post Box No. 8290

CIT Campus, IV Cross Road,

Taramani, Chennai - 600 113.

ANNEXURE TO ENDORSEMENT NO.16 DATED 20.03.2006

5) DC INDICATOR LIGHTS (BULB)

Rated operational voltage	24, 48, 110, 230 V DC
Rated voltage of light	24, 48, 110, 230 V DC
Rated voltage of lamp	24, 48, 130, 130 V DC
Rated power	2.2, 2.6, 2.6 Watts Max
Rated thermal power for mounting on metal plate	2.2, 2.6, 2.6 Watts Max
Rated thermal power for mounting on enclosure	2.2, 2.6, 2.6 Watts Max
Colour	Yellow, red, amber, blue, green, black, white, clear (for type and designation and colour, please see the catalogue enclosed)
Fixing hole diameter	22.5 mm, 22.5 mm, 22.5 mm, 22.5 mm
Means of connection	Single pin type holder small miniature with baynet cap holder
Nature of current applied and its frequency	DC
Type of lamp socket	Small miniature baynet cap holder with Nylon 66 (Grade 30) protective cover

DIRECTOR & HEAD (MARKS II)
BIS, CHENNAI

PAGE 3 OF 6



இந்திய தர நிர்ணய அமைவனம்
भारतीय मानक ब्यूरो
BUREAU OF INDIAN STANDARDS

दक्षिणी क्षेत्रीय कार्यालय

: पोस्ट बॉक्स नं. 8290

सी. आई. टी. कैम्पस, चौथा क्रॉस रोड,
तरावणी, चेन्नै - 600 113.

Southern Regional Office : Post Box No. 8290

CIT Campus, IV Cross Road,
Taramani, Chennai - 600 113.

ANNEXURE TO ENDORSEMENT NO.16 DATED 2003.02.06

6) AC INDICATOR LIGHTS (LED - LIGHT EMITTING DIODE)

Rated operational voltage	12, 24, 48, 110, 230 V AC
Rated voltage of light	12, 24, 48, 110, 230 V AC
Rated voltage of LED	2.2, 2.2, 2.2, 2.2 V AC Max
Rated current/power	25 mA/300 mW
Rated thermal power for mounting on metal plate	25 mA/300 mW
Rated thermal power for mounting on enclosure	25 mA/300 mW
Colour	Yellow, red, amber, blue, green, black, white, clear (for type and designation and colour, please see the catalogue enclosed)
Fixing hole diameter	22.5 mm, 22.5 mm, 22.5 mm, 22.5 mm
Means of connection	Solder connection
Nature of current applied and its frequency	AC 50 cycles
Type of lamp socket	Nylon 66 (Grade GF 30) protective cover

DIRECTOR & HEAD (MARKS II)
BIS, CHENNAI

PAGE 4 OF 6



இந்திய தர நிர்ணய அமைவனம்
भारतीय मानक ब्यूरो
BUREAU OF INDIAN STANDARDS

दक्षिणी क्षेत्रीय कार्यालय

: पोस्ट बॉक्स नं. 8290

सी. आई. टी. कॉम्प्लेक्स, चौथी क्रॉस रोड,
तरामणी, चेन्नै - 600 113.

Southern Regional Office : Post Box No. 8290

CIT Campus, IV Cross Road,
Taramani, Chennai - 600 113.

ANNEXURE TO ENDORSEMENT NO.16 DATED 2003.02.06

7) DC INDICATOR LIGHTS (LED - LIGHT EMITTING DIODE)

Rated operational voltage	12, 24, 48, 110, 230 V DC
Rated voltage of light	12, 24, 48, 110, 230 V DC
Rated voltage of lamp	2.2, 2.2, 2.2, 2.2 V DC Max
Rated current/power	25 mA/300 mW
Rated thermal power for mounting on metal plate	25 mA/300 mW
Rated thermal power for mounting on enclosure	25 mA/300 mW
Colour	Yellow, red, amber, blue, green, black, white, clear (for type and designation and colour, please see the catalogue enclosed)
Fixing hole diameter	22.5 mm, 22.5 mm, 22.5 mm, 22.5 mm
Means of connection	Solder connection
Nature of current applied and its frequency	DC
Type of lamp socket	Nylon 66 (Grade GF 30) protective cover

DIRECTOR & HEAD (MARKS II)
BIS, CHENNAI



இந்திய தர நிர்ணய அமைவனம்
भारतीय मानक ब्यूरो
BUREAU OF INDIAN STANDARDS

दक्षिणी क्षेत्रीय कार्यालय

: पोस्ट बॉक्स नं. 8290

सी. आई. टी. कैम्पस, चौथ क्रॉस रोड,
तरावणी, चेन्नै - 600 113.

Southern Regional Office : Post Box No. 8290

CIT Campus, IV Cross Road,
Taramani, Chennai - 600 113.

ANNEXURE TO ENDORSEMENT NO.16 DATED 20030266

8) MINIATURE LIMIT SWITCH

Rated operational voltage	: 240 V AC, 50 Hz
Rated operational current	: 3 A
Rated thermal current	: 10 Amp
Utilization category	: AC 15
Rated insulation voltage	: 600 V AC
Rated insulation voltage	: 1500 V
Pollution degree	: 2
Rated conditional short circuit current	: 1000 A
Number of poles	: Single

DIRECTOR & HEAD (MARKS II)
BIS, CHENNAI

PAGE 6 OF 6

The company named below has been authorized by CSA to represent the products listed in this record as "CSA Certified" and to affix the CSA Mark to these products according to the terms and conditions of the CSA Service Agreement and applicable CSA program requirements (including additional Markings).

File No: 114811 0 000

Class No: 3211 87 INDUSTRIAL CONTROL EQUIPMENT Miscellaneous Apparatus
- Certified to US Standards

SUBMITTOR

4576887 M/s Jai Balaji & Co.
89, Sidco Industrial Estate
P.O. No. 27
Ambattur
Chennai, 600098
India

FACTORY

4576887 M/s Jai Balaji & Co.
89, Sidco Industrial Estate
P.O. No. 27
Ambattur
Chennai, 600098
India

November 18, 2002 (Replaces: September 22, 1999)

- Rotary Switches, JRS-XX Series, Model Numbers and ratings are as follows:

Model No	Voltage	Current
JRS 9	400 V	6 A
JRS 18	400 V	10 A
JRS 27	400 V	16 A
JRS 45	400 V	25 A
JRS 63	400 V	32 A
JRS 81	400 V	40 A
JRS 90	400 V	63 A

- Limit Switches, JLS Series, JW Series, CEE EM 45 Series, the electrical ratings / mechanism / contacts are same for all the models and are as follows:

Model No	Contact Designation
JLS XXX	B300 / P600
JW XX	B300 / P600
CEE EM 45-XX	B300 / P600
JC XXXX	B300 / P600
JB XXXX	B300 / P600

Note: The suffixes -XXX indicate Model Numbers with different lever heads.

- Proximity Switches JB Series details are given below:

Model No	Type	DC Volts	DC Amps	AC Volts	AC Amp
JB 8 PILM	3 Wire DC	30 V DC	200 mA	--	--
JB 12 PIFM	3 Wire DC	30 V DC	200 mA	--	--
JB 18 PILM	3 Wire DC	30 V DC	200 mA	--	--
JB 30 PILM	3 Wire DC	30 V DC	200 mA	--	--
JB 36 AILM	2 Wire DC	--	--	230 V	300 mA
JB 50 PILM	2 Wire DC	30 V DC	200 mA	--	--

- Contact Switch Element for Push Buttons, Model Nos and Rating are as follows:

Model No	Contact Type	Designation	AC Rating	DC Rating
			Voltage/Current	Voltage/Current
JB1	N O	B300/P600	400 V/10 A	600 V/5 A
JB2	N C	B300/P600	400 V/10 A	600 V/5 A

● Pilot Lights

Model	Rated Voltage	Max Current mA
ML, PL	12 V, 24V, 48 V,	25 mA
	110 V ac/dc, 230 V ac and 220 V dc	
MB	12 V ac/dc	180 mA
	24 V ac/dc	80 mA
	48 V ac/dc	40 mA
	110 V ac/dc, 230 V ac and 220 V dc	25 mA

Note: These devices are certified as components only for use in other certified equipment where the suitability of the combination is determined by CSA International.

Certificate of Compliance

To the Low Voltage Directive, 73/23/EEC and 93/68/EEC

Project No.: DL 06000125-71Q
Type of Product: Plugs, socket-outlets and couplers for Industrial purposes
Document holder: JAIBALAJI and Co.
89 (New:107), SIDCO Industrial Estate,
Post Box No.27, Ambattur, Chennai-600 098. India.
Manufacturer: JAIBALAJI and Co.
89 (New:107), SIDCO Industrial Estate,
Post Box No.27, Ambattur, Chennai-600 098. India.
**Type designation :
Technical data** Ref Annexure-"A"

This Notice of Presumption of Conformity has been based on the following:

- Based on Safety test report issued by Intertek with reference number DL06000125-001
- **Applicable standard:**
- EN 60309-1:1999 + A11:2004 - Plugs, socket-outlets and couplers for industrial purposes –part 1 General requirements.
- EN 60309-2:1999 +A11:2004 – Plugs, socket-outlets and couplers for industrial purposes –part 2 Dimensional interchangeability requirements for pin and contact-tube accessories.
- **Other info: Manufacturer's Technical File**
- **Manufacturer ensures that the manufactured products will be identical to the samples evaluated**

We confirm that the samples evaluated, according to our review of the above test reports and with our complementary evaluation, without any reasonable doubt will fulfil the requirements concerning electrical safety according to above mentioned standards harmonised with the Low Voltage Directive 73/23/EEC and 93/68/EEC. Obvious electrical safety risks other than those covered by the above standards were not revealed during our evaluations.

The product was found to contain the required items for CE Markings according to:
The Low Voltage Directive 73/23/EEC amended by 93/68/EEC

Note: Products entering the European Union are subject to the requirements set forth in the European Directives. It is the responsibility of the person placing the product on the European market to ensure compliance with applicable Directives. Our services are intended to provide you with the data needed to determine compliance, but the person placing the product on the European market still has the responsibility to ensure each product complies with the applicable Directives. Our report under this investigation will not imply that ETL SEMKO has Listed, Verified, or Recognized the product, nor does it authorize the use of Listing or Verification Marks or other reference to ETL SEMKO, on or in connection with the product.

Intertek Testing Services India Pvt. Limited
E-20, Phase B-1, Mohan Co-Operative, Industrial Area,
Mathura Road, New Delhi-110044.
Tel: + 91(0)11 41678700 Fax: +91 (0)11 41678701
<http://www.intertek-etlsemko.com>

G. Raghunath
Authorised Signatory
13th September 2007.



This certificate may only be reproduced in its entirety and without any change.



Annexure -A

Sl. No	Description		Model/Type
1	16 Amps 2 Pin + Earth	IP 44 Industrial Angled Socket	Type : J 203 AS
2	16 Amps 2 Pin + Earth	IP 44 Industrial Angled Plug	Type : J 203 AP
3	16 Amps 2 Pin + Earth	IP 44 Industrial Straight Socket	Type : J 203 SS
4	16 Amps 2 Pin + Earth	IP 44 Industrial Straight Plug	Type : J 203 SP
5	16 Amps 3 Pin + Earth + Neutral	IP 44 Industrial Angled Socket	Type : J 205 AS
6	16 Amps 3 Pin + Earth + Neutral	IP44 Industrial Straight Socket	Type : J 205 SS
7	16 Amps 3 Pin + Earth + Neutral	IP 44 Industrial Straight Plug	Type : J 205 SP
8	16 Amps 3 Pin + Earth + Neutral	IP 67 Industrial Straight Socket connector	Type : J 205 SC
9	32 Amps 2 Pin + Earth	IP 44 Industrial Angled Socket	Type : J 323 AS
10	32 Amps 2 Pin + Earth	IP 44 Industrial Straight Plug	Type : J 323 SP
11	32 Amps 3 Pin + Earth + Neutral	IP 44 Industrial Angled Socket	Type : J 325 AS
12	32 Amps 3 Pin + Earth + Neutral	IP 44 Industrial Straight Plug	Type : J 325 SP
13	32 Amps 3 Pin + Earth + Neutral	IP 67 Industrial Angled Socket	Type : J 325 AS
14	32 Amps 3 Pin + Earth + Neutral	IP 67 Industrial Straight Plug	Type : J 325 SP
15	32 Amps 3 Pin + Earth + Neutral	IP 67 Industrial Straight Socket Connector	Type : J 325 SC
16	63 Amps 3 Pin + Earth + Neutral	IP 67 Industrial Angled Socket	Type : J 635 AS
17	63 Amps 3 Pin + Earth + Neutral	IP 67 Industrial Straight Plug	Type : J 635 SP
18	63 Amps 3 Pin + Earth + Neutral	IP 67 Industrial Straight Socket Connector	Type : J 635 SC

Technical Specification : 2Pin + Earth - 230V, 50Hz, single Phase
: 3Pin + Earth + Neutral - 230V, 50Hz, single Phase
- 415V, 50Hz, Three Phase.

Note: Products entering the European Union are subject to the requirements set forth in the European Directives. It is the responsibility of the person placing the product on the European market to ensure compliance with applicable Directives. Our services are intended to provide you with the data needed to determine compliance, but the person placing the product on the European market still has the responsibility to ensure each product complies with the applicable Directives. Our report under this investigation will not imply that ETL SEMKO has Listed, Verified, or Recognized the product, nor does it authorize the use of Listing or Verification Marks or other reference to ETL SEMKO, on or in connection with the product.











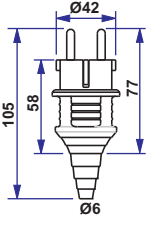

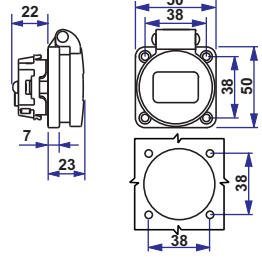

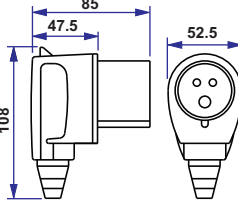

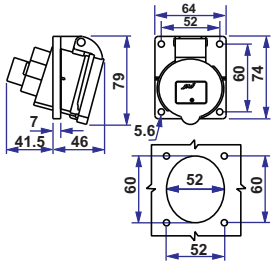

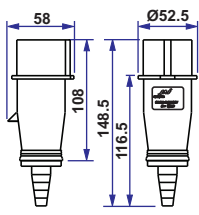
Intertek Testing Services India Pvt. Limited
 E-20, Phase B-1, Mohan Co-Operative, Industrial Area,
 Mathura Road, New Delhi-110044.
 Tel: + 91(0)11 -41678700 Fax: +91 (0)11 41678701
<http://www.intertek-etlsemko.com>

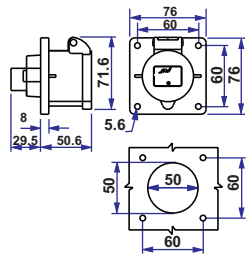

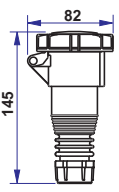
G. Raghunath
 Authorised Signatory
 13th September 2007.

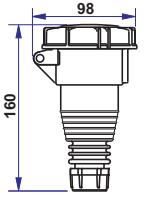

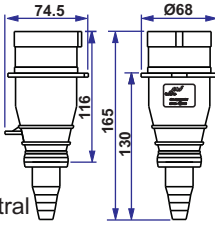
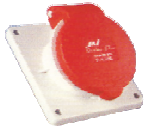
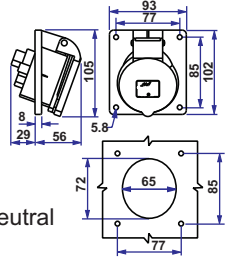
This certificate may only be reproduced in its entirety and without any change.

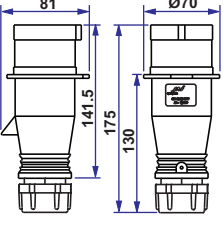
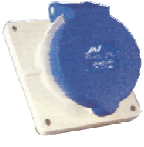
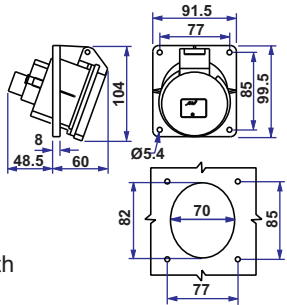
ENGINEERING PLASTIC INDUSTRIAL HEAVY DUTY PLUGS , SOCKETS AND CONNECTORS WITH (C) MARK CATALOGUE CUM PRICE LIST

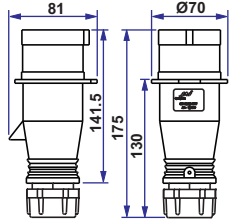
 <p>16 Amps 2Pin Straight Plug</p>	 <p style="text-align: center;"> $\varnothing 42$ 105 58 77 $\varnothing 6$ </p>	<p>Model J162SP IP44 M.R.P. Rs.234</p>	 <p>16 Amps 2Pin Straight Socket</p>	 <p style="text-align: center;"> 22 50 38 38 50 7 23 38 38 </p>	<p>Model J162SS IP44 M.R.P. Rs.234</p>
 <p>16 Amps 2Pin+Earth Angled Plug</p>	 <p style="text-align: center;"> 85 47.5 52.5 108 </p>	<p>Model J203AP IP44 M.R.P. Rs.432</p>	 <p>16 Amps 2Pin+Earth Angled Socket</p>	 <p style="text-align: center;"> 64 52 79 60 74 7 46 41.5 5.6 60 52 60 52 </p>	<p>Model J203AS IP44 M.R.P. Rs.396</p> <p>J203AS IP67 M.R.P. Rs.459</p>
 <p>16 Amps 2Pin+Earth Straight Plug</p>	 <p style="text-align: center;"> 58 108 148.5 116.5 $\varnothing 52.5$ </p>	<p>Model J203SP IP44 M.R.P. Rs.360</p> <p>J203SP IP67 M.R.P. Rs.468</p>	 <p>16 Amps 2Pin+Earth Straight Socket</p>	 <p style="text-align: center;"> 76 60 71.6 60 76 8 5.6 29.5 50.6 50 50 60 60 </p>	<p>Model J203SS IP44 M.R.P. Rs.414</p> <p>Model J205SS IP44 M.R.P. Rs.639</p> <p>J205SS IP67 M.R.P. Rs.711</p>
 <p>16 Amps 2Pin+Earth Straight Connector</p>	 <p style="text-align: center;"> 82 145 </p>	<p>Model J203SC IP44 M.R.P. Rs.495</p> <p>J203SC IP67 M.R.P. Rs.927</p>	 <p>16 Amps 3Pin+Earth+Neutral Straight Connector</p>	 <p style="text-align: center;"> 98 160 </p>	<p>Model J205SC IP44 M.R.P. Rs.558</p> <p>J205SC IP67 M.R.P. Rs.981</p>
 <p>16 Amps 3Pin+Earth+Neutral Straight Plug</p>	 <p style="text-align: center;"> 74.5 116 165 130 $\varnothing 68$ </p>	<p>Model J205SP IP44 M.R.P. Rs.486</p> <p>J205SP IP67 M.R.P. Rs.729</p>	 <p>16 Amps 3Pin+Earth+Neutral Angled Socket</p>	 <p style="text-align: center;"> 93 77 105 35 102 8 5.8 29 56 72 65 85 77 </p>	<p>Model J205AS IP44 M.R.P. Rs.612</p> <p>J205AS IP67 M.R.P. Rs.720</p>
 <p>32 Amps 2Pin+Earth Straight Plug</p>	 <p style="text-align: center;"> 81 141.5 175 130 $\varnothing 70$ </p>	<p>Model J323SP IP44 M.R.P. Rs.522</p> <p>J323SP IP67 M.R.P. Rs.783</p>	 <p>32 Amps 2Pin+Earth Angled Socket</p>	 <p style="text-align: center;"> 91.5 77 104 85 99.5 8 60 48.5 $\varnothing 5.4$ 82 70 85 77 </p>	<p>Model J323AS IP44 M.R.P. Rs.675</p> <p>J323AS IP67 M.R.P. Rs.765</p>



Model
J324SP IP44
M.R.P. **Rs.621**

J324SP IP67
M.R.P. **Rs.801**

32 Amps 3Pin+Earth
Straight Plug

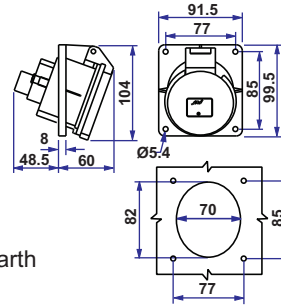

Model
J324AS IP44
M.R.P.**Rs.738**

J324AS IP67
M.R.P.**Rs.819**

32 Amps 3Pin+Earth
Angled Socket

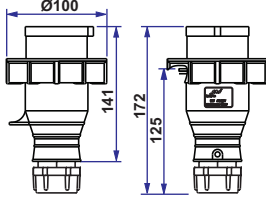

Model
J325SP IP44
M.R.P. **Rs.657**

J325SP IP67
M.R.P. **Rs.882**

32 Amps 3Pin+Earth+Neutral
Straight Plug

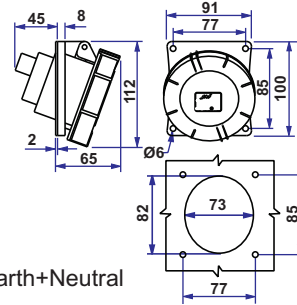
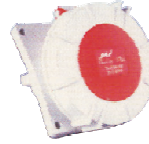

Model
J325AS IP44
M.R.P. **Rs.783**

J325AS IP67
M.R.P. **Rs.855**

32 Amps 3Pin+Earth+Neutral
Angled Socket

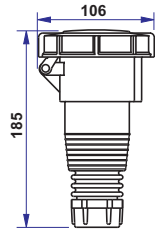

Model
J325SC IP44
M.R.P. **Rs.819**

J325SC IP67
M.R.P. **Rs.1215**

32 Amps 3Pin+Earth+Neutral
Straight Connector

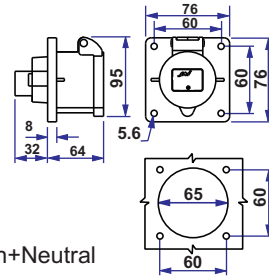

Model
J325SS IP44
M.R.P. **Rs.783**

32 Amps 3Pin+Earth+Neutral
Straight Socket

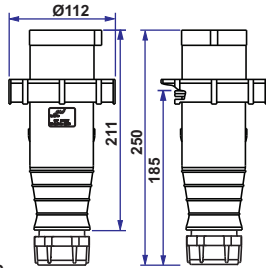

Model
J634SP IP44
M.R.P. **Rs.2088**

J634SP IP67
M.R.P. **Rs.2250**

63 Amps 3Pin+Earth
Straight Plug

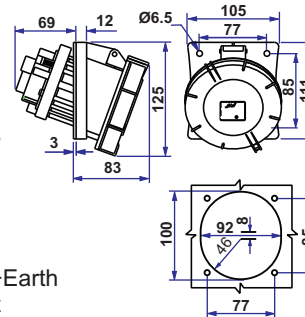

Model
J634AS IP44
M.R.P.**Rs.2214**

J634AS IP67
M.R.P.**Rs.2538**

63 Amps 3Pin+Earth
Angled Socket

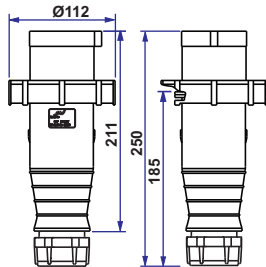

Model
J635SP IP44
M.R.P. **Rs.2385**

J635SP IP67
M.R.P. **Rs.2628**

63 Amps 3Pin+Earth+Neutral
Straight Plug

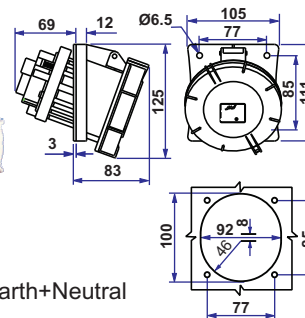

Model
J635AS IP44
M.R.P. **Rs.2691**

J635AS IP67
M.R.P. **Rs.2826**

63 Amps 3Pin+Earth+Neutral
Angled Socket

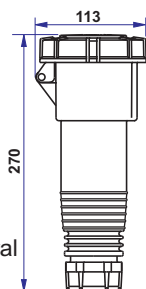

Model
J635SC IP67
M.R.P. **Rs.3033**

63 Amps 3Pin+Earth+Neutral
Straight Connector

Wall Mounting Sockets - 16A

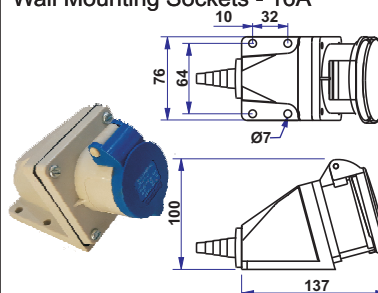

Model
J203WMSS IP44
M.R.P. **Rs.540**

Model
J205WMSS IP67
M.R.P. **Rs.855**

J205WMSS IP44
M.R.P. **Rs.783**

125 Amps 3Pin+Earth+Neutral
Straight Plug

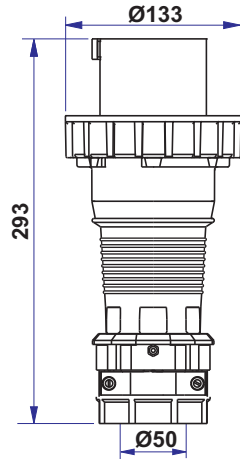

Model
J1255SP IP67
M.R.P. **Rs.5274**

125 Amps 3Pin+Earth+Neutral
Straight Socket

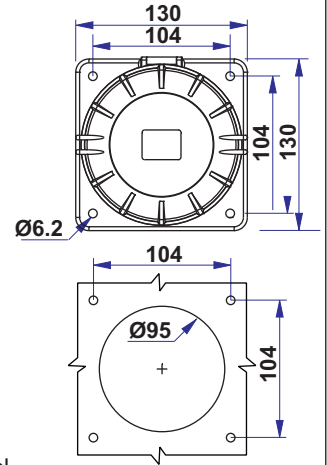
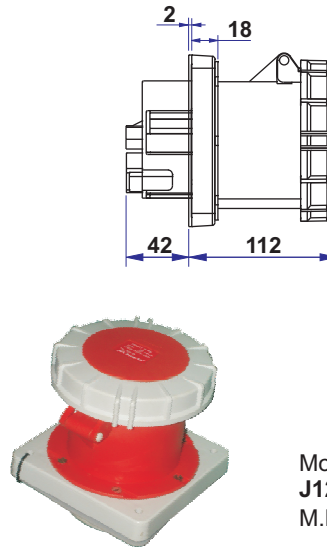

Model
J1255SS IP67
M.R.P. **Rs.5427**

125 Amps 3Pin+Earth+Neutral
Straight Connector

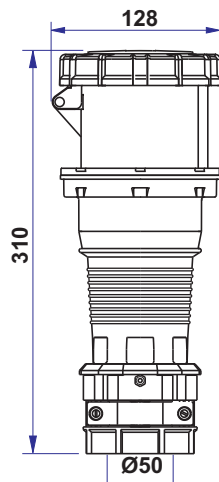

Model
J1255SC IP67
M.R.P. **Rs.5805**

125 Amps 3Pin+Earth+Neutral
Angled Socket

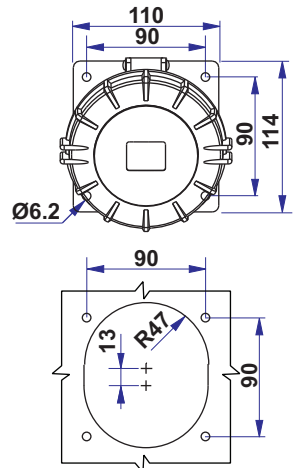
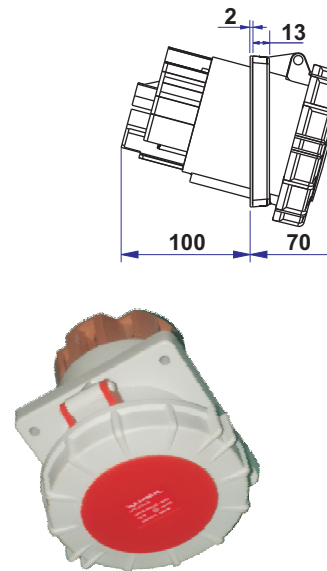

Model
J1255AS IP67
M.R.P. **Rs.5445**

Wall Mounting Sockets - 32A

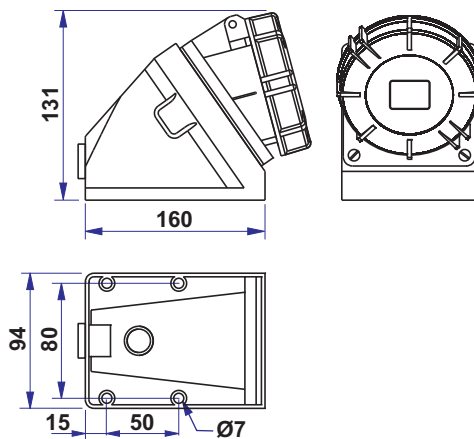
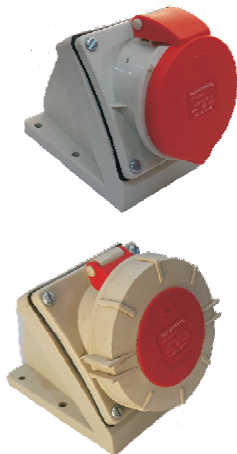

Model
J205WMAS IP44
M.R.P. **Rs.792**
J205WMAS IP67
M.R.P. **Rs.900**
J323WMAS IP44
M.R.P. **Rs.864**
J323WMAS IP67
M.R.P. **Rs.954**
J324WMAS IP44
M.R.P. **Rs.945**
J324WMAS IP67
M.R.P. **Rs.1026**
J325WMAS IP44
M.R.P. **Rs.972**
J325WMAS IP67
M.R.P. **Rs.1044**

A / C BOX

Fully Insulated Plastic A/c Box With 16/20Amps 2Pin + Earth Angled Socket And Plug

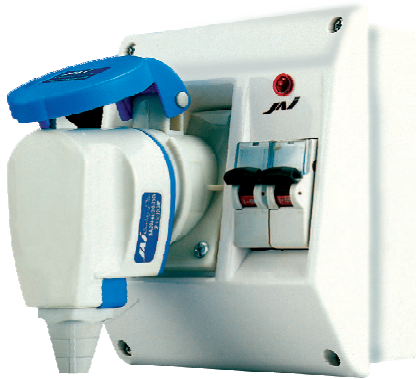

M.R.P. Rs.819

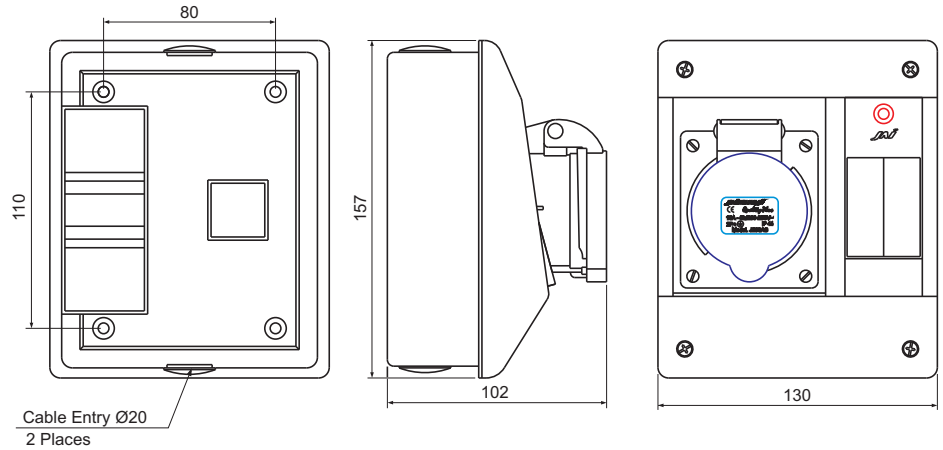

Position of ground contact with respect to major for various voltages and frequencies, designated by Clock face positions in accordance with table 104 taken EN 60309 - 2 : 1992

Type	Frequency Hz	Rated Operating Voltage V	Position of Ground Contact		
			16A/32A	63A	125A
2P+E	50 and 60	200 to 250	6	6	-
3P+N+E	50 and 60	200/346/ to 240/415	6	6	6

Operation	On Load	No Load
16A	5000	
32A	1000	1000
63A	1000	1000
125A	1000	1000

Product	:	Industrial Plug & Socket
Reference Standards	:	IS/IEC 60309 Part 1 and Part 2
Working temperature	:	-25 degree C to + 80 degree C
Insulation Voltage	:	690V AC/DC
Dielectric Strength	:	2500V per/minute
Insulation Resistance	:	>5 Meg. Ohm.
Contact Resistance	:	<25 Mili. Ohm.
Max. Withdrawal force	:	<400 N
Rated Operating Voltage	:	240V/415V (AC)
Rated Operating Current	:	16A/32A/63A/125A
No. Of Poles	:	3,4 & 5
Breaking Capacity	:	1.25 times the rated current, 1.1 times the rated Voltage, power factor 0.6lag.

COLOUR CODING

If, in addition of regulation marking, the rated operating voltage is also indicated by a colour coding, this must be in accordance with IEC 309

Rated Operating Voltage	Colour code
200 to 250 V	Blue
380 to 480 V	Red

CAM OPERATED ROTARY SWITCHES WITH CATALOGUE CUM PRICE LIST

IS/IEC:60947
Pt-5/Sec-1



MARKS

Technical Specifications

Utilisation Category	: AC 15/DC 13 as per IS/IEC:60947
Thermal Current	: 6A to 400 A
Maximum switching cycle	: Class 300
Class of mechanical durability	: 3
Operating Temperature	: -25°C to +55°C
Rated Voltage	: 415V AC / 240V DC
Rated impulse voltage	: 1.5 KV
Frequency	: 50 Hz
Rated Insulation voltage	: 600V AC

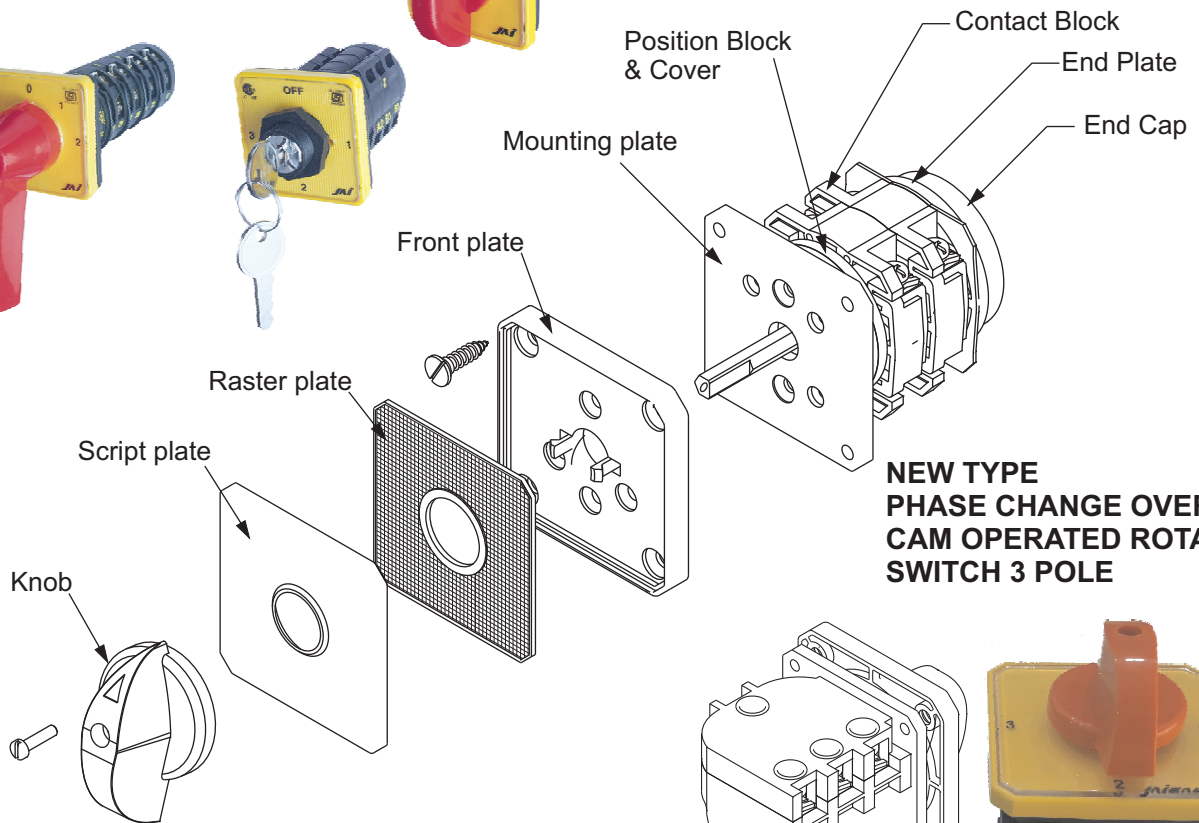
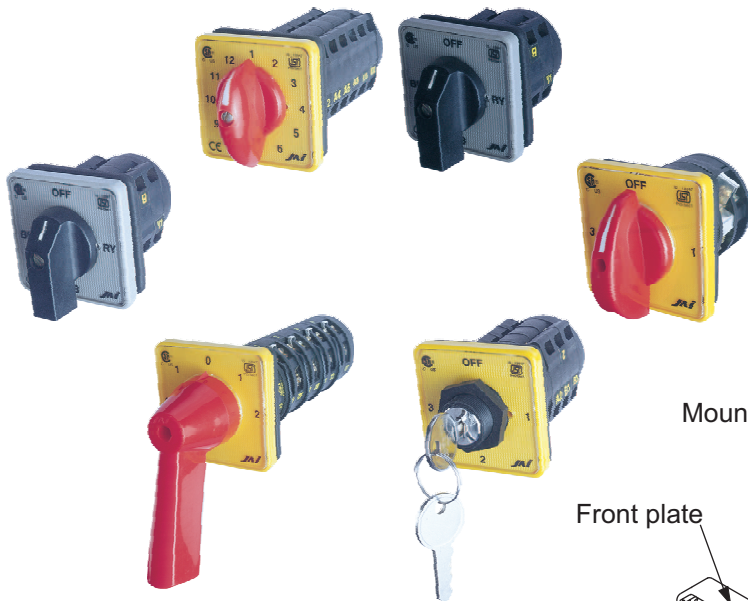

**NEW TYPE
PHASE CHANGE OVER
CAM OPERATED ROTARY
SWITCH 3 POLE**

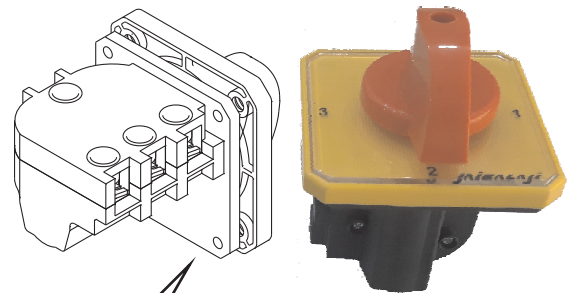

**40A MRP. Rs 774
63A MRP. Rs 882**

Amps	Outer Diameter	Position Block	Contact Block CB												End Plate	End Cap
			1	2	3	4	5	6	7	8	9	10	11	12		
6 & 10	35	11.0	9.5	19.0	28.5	38.0	47.5	57.0	66.5	76.0	85.5	95.0	104.5	114.0	4.0	5.0
16	46	13.5	12	24	36	48	60	72	84	96	108	120	132	144	4.0	7.8
25&32	50	13.5	15	30	45	60	75	90	105	120	135	150	165	180	5.5	7.8
40&63	70	14.0	21.3	42.6	63.9	85.2	106.5	127.8	149.1	170.4	191.7	213	234.3	255.6	5.0	10.0
100&200	88	19.0	32	64	96	128	160	192	224	256	288	320	352	384	6.0	10.0
400	88	19.0	64	128	192	256	320	384							6.0	10.0

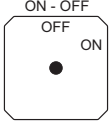
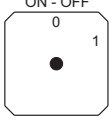
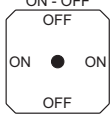
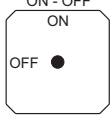
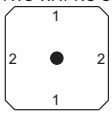
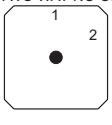
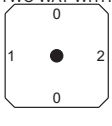
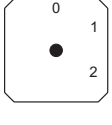
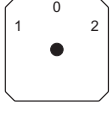
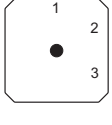
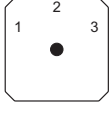
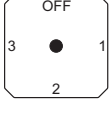
SWITCHING POSITION	P O L E	MODEL	6A M.R.P. Rs.	10A M.R.P. Rs.	16A M.R.P. Rs.	25A M.R.P. Rs.	32A M.R.P. Rs.	40A M.R.P. Rs.	63A M.R.P. Rs.	100A M.R.P. Rs.	200A M.R.P. Rs.
 ON - OFF OFF ON 60°	1	27001	171	225	333	486	612	756	873	3357	4338
	2	27002	207	270	396	549	693	855	990	4455	5994
	3	27003	243	324	450	621	783	972	1107	5877	7434
	4	27004	279	360	513	693	864	1044	1206	6445	9351
 ON - OFF 0 1 60°	1	27001J	171	225	333	486	612	756	873	3357	4338
	2	27002J	207	270	396	549	693	855	990	4455	5994
	3	27003J	243	324	450	621	783	972	1107	5877	7434
	4	27004J	279	360	513	693	864	1044	1206	6445	9351
 ON - OFF OFF ON ON OFF 90°	1	27195	171	225	333	486	612	756	873	3357	4338
	2	27198	207	270	396	549	693	855	990	4455	5994
	3	27197	243	324	450	621	783	972	1107	5877	7434
	4	27196	279	360	513	693	864	1044	1206	6445	9351
 ON - OFF ON OFF 90°	1	27191	171	225	333	486	612	756	873	3357	4338
	2	27192	207	270	396	549	693	855	990	4455	5994
	3	27199	243	324	450	621	783	972	1107	5877	7434
	4	27194	279	360	513	693	864	1044	1206	6445	9351
 TWO WAY NO OFF 1 2 2 1 90°	1	27037	207	270	396	531	693	855	990	4428	5994
	2	27038	243	324	450	621	783	972	1107	5877	7434
	3	27039	279	360	513	693	864	1044	1206	6444	9351
	4	27040	324	414	576	774	954	1143	1323	6957	11295
 TWO WAY NO OFF 1 2 60°	1	27037J	207	270	396	531	693	855	990	4428	5994
	2	27038J	243	324	450	621	783	972	1107	5877	7434
	3	27039J	279	360	513	693	864	1044	1206	6444	9351
	4	27040J	324	414	576	774	954	1143	1323	6957	11295
 TWO WAY WITH OFF 0 1 2 0 90°	1	27151	207	270	396	531	693	855	990	4428	5994
	2	27152	243	324	450	621	783	972	1107	5877	7434
	3	27153	279	360	513	693	864	1044	1206	6957	9351
	4	27154	324	414	576	774	954	1143	1323	7794	11295
 TWO WAY WITH OFF 0 1 2 60°	1	27059	207	270	396	531	693	855	990	4428	5994
	2	27079	243	324	450	621	783	972	1107	5877	7434
	3	27099	279	360	513	693	864	1044	1206	6957	9351
	4	27130	324	414	576	774	954	1143	1323	7794	11295
 TWO WAY WITH OFF 0 1 2 60°	1	27025	207	270	396	531	693	855	990	4428	5994
	2	27026	243	324	450	621	783	972	1107	5877	7434
	3	27027	279	360	513	693	864	1044	1206	6957	9351
	4	27028	324	414	576	774	954	1143	1323	7794	11295
 THREE WAY NO OFF 1 2 3 60°	1	27049	243	324	450	621	783	972	1107	4419	
	2	27069	279	360	513	693	864	1044	1206	6813	
	3	27089	324	414	576	774	954	1143	1323	9270	
	4	27120	351	459	630	846	1035	1251	1431	12006	
 THREE WAY NO OFF 2 1 3 60°	1	27049J	243	324	450	621	783	972	1107	4419	
	2	27069J	279	360	513	693	864	1044	1206	6813	
	3	27089J	324	414	576	774	954	1143	1323	9270	
	4	27120J	351	459	630	846	1035	1251	1431	12006	
 THREE WAY WITH OFF OFF 3 1 2 90°	1	27060	243	324	450	621	783	972	1107	4419	6498
	2	27080	279	360	513	693	864	1044	1206	6813	11295
	3	27100	324	414	576	774	954	1143	1323	9270	15237
	4	27131	351	459	630	846	1035	1251	1431	12006	16470

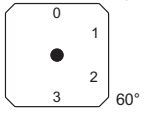
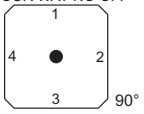
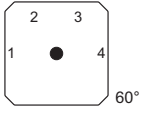
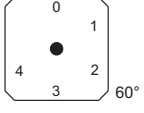
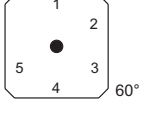
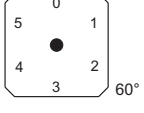
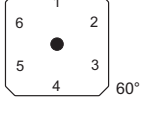
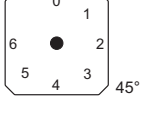
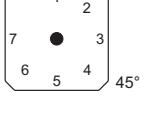
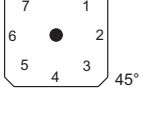
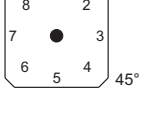
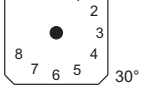
SWITCHING POSITION	P O L E	MODEL	6A M.R.P. Rs.	10A M.R.P. Rs.	16A M.R.P. Rs.	25A M.R.P. Rs.	32A M.R.P. Rs.	40A M.R.P. Rs.	63A M.R.P. Rs.	100A M.R.P. Rs.	200A M.R.P. Rs.
THREE WAY WITH OFF 	1	27060J	243	324	450	621	783	972	1107	4428	
	2	27080J	279	369	513	693	864	1053	1206	6813	
	3	27100J	324	414	576	774	954	1143	1323	9270	
	4	27131J	351	468	630	846	1035	1251	1431	12006	
FOUR WAY NO OFF 	1	27050	279	369	513	693	864	1053	1206	4419	
	2	27070	324	414	576	774	954	1143	1323	6813	
	3	27090	351	468	630	846	1035	1251	1431	10458	
	4	27121	396	513	693	918	1125	1350	1539	12006	
FOUR WAY NO OFF 	1	27050J	279	369	513	693	864	1053	1206	4419	
	2	27070J	324	414	576	774	954	1143	1323	6813	
	3	27090J	351	468	630	846	1035	1251	1431	9270	
	4	27121J	396	513	693	918	1125	1350	1539	12006	
FOUR WAY WITH OFF 	1	27061	279	369	513	693	864	1053	1206		
	2	27081	324	414	576	774	954	1143	1323		
	3	27101	351	468	630	846	1035	1251	1431	14895	
	4	27132	396	513	693	918	1125	1350	1539	21051	
FIVE WAY NO OFF 	1	27051	324	414	576	774	954	1143	1323		
	2	27071	351	468	630	846	1035	1251	1431		
	3	27091	396	513	693	918	1125	1350	1539		
	4	27122	432	567	756	990	1206	1440	1647		
FIVE WAY WITH OFF 	1	27062	324	414	576	774	954	1143	1323		
	2	27082	396	513	693	918	1125	1350	1539		
	3	27102	432	567	756	990	1206	1440	1647		19863
SIX WAY NO OFF 	1	27052	396	513	693	774	954	1143	1323	6183	
	2	27072	432	567	756	918	1125	1350	1539	12339	
	3	27092	468	612	828	990	1206	1440	1647	20844	
SIX WAY WITH OFF 	1	27063	396	513	693	774	954	1143	1323		10854
	2	27083	432	567	756	918	1125	1350	1539		
	3	27103	468	612	828	990	1206	1440	1647		
SEVEN WAY NO OFF 	1	27053	432	567	756	918	1125	1350	1539		
	2	27073	468	612	828	990	1206	1440	1647		
	3	27193	504	666	900	1062	1296	1539	1764		
SEVEN WAY WITH OFF 	1	27064	468	567	756	918	1125	1350	1539		
	2	27084	504	612	828	990	1206	1440	1647		
	3	27104	531	666	900	1062	1296	1539	1764		
EIGHT WAY NO OFF 	1	27054	468	567	756	918	1125	1350	1539		
	2	27074	504	612	828	990	1206	1440	1647		
	3	27094	531	666	900	1062	1296	1539	1764		
EIGHT WAY WITH OFF 	1	27065	468	567	756	918	1125	1350	1539		
	2	27085	531	666	828	990	1206	1440	1647		

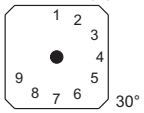
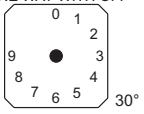
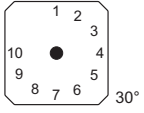
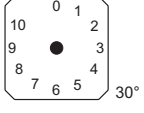
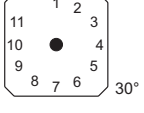
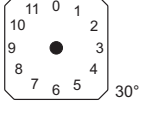
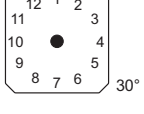
SWITCHING POSITION	P O L E	MODEL	6A M.R.P. Rs.	10A M.R.P. Rs.	16A M.R.P. Rs.	25A M.R.P. Rs.	32A M.R.P. Rs.	40A M.R.P. Rs.	63A M.R.P. Rs.	100A M.R.P. Rs.	200A M.R.P. Rs.
NINE WAY NO OFF 	1	27055	531	666	882	990	1206	1440	1647		
	2	27075	576	711	954	1062	1287	1539	1764		
NINE WAY WITH OFF 	1	27066	531	666	882	990	1206	1440	1647		
	2	27086	576	711	954	1062	1287	1539	1764		
TEN WAY NO OFF 	1	27056	576	711	954	1062	1287	1539	1764		
	2	27076	612	756	1017	1134	1377	1638	1872		
TEN WAY WITH OFF 	1	27067	576	711	954	1062	1287	1539	1764		
	2	27087	612	756	1017	1134	1377	1638	1872		
ELEVEN WAY NO OFF 	1	27057	612	756	1017	1062	1377	1638	1872		
	2	27077	657	801	1080	1134	1467	1728	1980		
ELEVEN WAY WITH OFF 	1	27068	612	801	1080	1206	1467	1728	1980		
	2	27088	657	855	1134	1287	1548	1827	2088		
TWELVE WAY NO OFF 	1	27058	657	855	1134	1287	1548	1827	2088		
	2	27078	684	909	1197	1359	1638	1935	2205		

400 Amps Cam Operated Rotary Switches

S.No.	MODEL	MRP Rs.	S.No.	MODEL	MRP Rs.	S.No.	MODEL	MRP Rs.
1	27195	7389	11	27039	21735	21	27100	32832
2	27198	12573	12	27037J	12573	22	27131	15768
3	27197	17010	13	27038J	17010	23	27050	15534
4	27196	21735	14	27039J	21735	24	27070	25731
5	27191	7389	15	27151	13914	25	27090	36234
6	27192	12573	16	27152	22788	26	27121	18487
7	27199	17010	17	27153	30024	27	27051	13761
8	27194	21735	18	27154	33138	28	27052	12663
9	27037	12573	19	27060	14787	29	27072	17163
10	27038	17010	20	27080	23265	30	27092	32400

MOTOR CONTROL SWITCHES

Cam Operated Rotary switches suitable for switching, controlling and starting 3 phase 415 volts 50Hz squirrel cage induction motors upto 5.5 Kw for AC1, AC3 and AC4 duties conforming to IS/IEC 60947 / Pt.5/Sec1

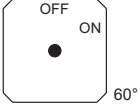
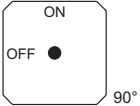
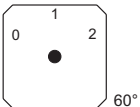
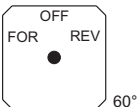
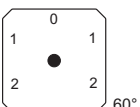
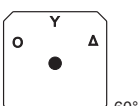
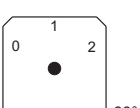
SWITCHING POSITION	MODEL	DESCRIPTION	16A M.R.P. Rs.	25A M.R.P. Rs.	32A M.R.P. Rs.	40A M.R.P. Rs.	63A M.R.P. Rs.	100A M.R.P. Rs.	200A M.R.P. Rs.
	27003	ON - OFF, 2 Position 60° Switch	486	657	801	1008	1125	5904	7452
	27199	ON - OFF, 2 Position 90° Switch	486	657	801	1008	1125		
	27212	Double Speed Forward Switch with OFF		783	918			7002	7497
	27211	Forward Reverse Control Switch with OFF	576	630	711	774	891	5193	8541
	27217	Double Speed Forward Reverse Switch with OFF	918	1035	1188				
	27200	Star / Delta		747	855	1296	1476		
	27219	Separate Winding	747						

VOLT METER SELECTOR SWITCHES

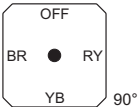
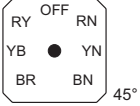
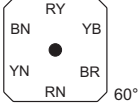
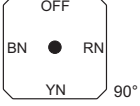
SWITCHING POSITION	P O L E	MODEL	DESCRIPTION	6 A M.R.P. Rs.	10 A M.R.P. Rs.
	3	27312	To measure Voltage between Phases with OFF	288	378
	3	27313	To measure Voltage between Phases & neutral with OFF	351	486
	3	27314	To measure Voltage between Phases to Phase, neutral with OFF	441	549
	3	27311	To measure Voltage between Phases to neutral with OFF	495	513

AMMETER SELECTOR SWITCHES

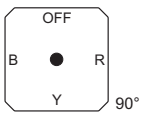
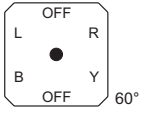
SWITCHING POSITION	POLE	MODEL	DESCRIPTION	6 A M.R.P. Rs.	10 A M.R.P. Rs.
	3	27325	To measure current in each Phase with OFF through CT	378	432
	3	90721	To read current in each phases & Leakage or balance current	585	666

CAM OPERATED SPRING RETURN ROTARY SWITCHES

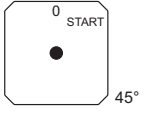
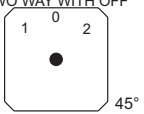
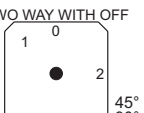
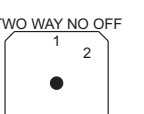
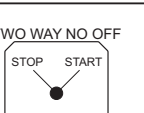
SWITCHING POSITION	POLE	MODEL		6A M.R.P. Rs.	10A M.R.P. Rs.	16A M.R.P. Rs.	25A M.R.P. Rs.	32A M.R.P. Rs.
	1	27351	ON - OFF Spring Return to OFF	234	288	576	1071	1260
	2	27352		279	342	621	1143	1350
	3	27353		333	396	684	1215	1431
	4	27354		378	441	747	1296	1521
	1	27361	Double throw Spring Return both sides Center OFF	243	315	612	1143	1350
	2	27362		288	351	675	1215	1431
	3	27363		342	405	738	1296	1521
	1	27364	Three positions with one position spring return to OFF	243	315	612	1143	1350
	2	27365		288	351	675	1215	1431
	3	27369		342	405	738	1296	1521
	1	27371	Two position spring return Switches	243	315	612	1143	1350
	2	27372		288	351	675	1215	1431
	3	27373		342	405	738	1296	1521
	1	27300	Push button application Spring return Switches	243	315	612	1143	1350
	2	27388		288	351	675	1215	1431

ACCESSORIES FOR ROTARY SWITCHES (SPARES)

MARKING PLATES 10 - 16 Amps 54.00 32 Amps 63.00 63 Amps 63.00	M.R.P. Each Rs.	HANDLES PISTOL GRIP 16 Amps 81.00 32 Amps 99.00 63 Amps 117.00	M.R.P. Each Rs.	LOCKS 16,32 Amps 216.00 63 Amps 234.00	M.R.P. Each Rs.
SPECIAL MARKING PLATES 16 Amps 54.00 32 Amps 63.00 63 Amps 63.00	M.R.P. Each Rs.	BALL HANDLE 16 Amps 81.00 32 Amps 99.00 63 Amps 117.00	M.R.P. Each Rs.	PANEL FIXING SCREWS 100 Nos Packet 10,16,32Amps 81.00 100 Nos Packet 63 Amps 99.00	M.R.P. Each Rs.
KNOBBS 10 Amps 54.00 16 Amps 63.00 32 Amps 63.00 63 Amps 81.00	M.R.P. Each Rs.	MOUNTING PLATES FOR JO-9 & JB-9 47.5 x 47.5 x 1.6 54.00 60 x 60 x 1.6 63.00 70 x 70 x 1.6 63.00 84 x 84 x 1.6 81.00 96 x 96 x 1.6 81.00	M.R.P. Each Rs.		

JAIBALAJI
CONTROL GEARS PVT. LTD

Post Box No. 27, 89 (New No. 107),SIDCO Industrial Estate,Ambattur, Chennai -600 098. India
 Phone: +91 44 26251279 / 26257859 / 26254470 Fax: +91 44 26255038.
 E-mail: dchandramohan@jaibalaji.firm.in Web: jaibalaji.in

LED ILLUMINATED PUSH BUTTONS, PILOT LIGHTS SELECTOR ACTUATORS Ø22.5



















CATALOGUE CUM PRICE LIST







WITH    MARKS

Type & Description		M.R.P. Rs. Metal	M.R.P. Rs. Plastic	Type & Description		M.R.P. Rs. Metal	M.R.P. Rs. Plastic
9FA 	Flush Actuator (Yellow, Red, Blue Green, Black, White Specify colour)	99.00	67.50	9MLKA-2B/6B 	Stayput Mushroom Actuator with key (Press to lock and key to release, Key removable in actuated and unactuated positions) Red/Black	360.00	297.00
9PA 	Projecting Actuator (Yellow, Red, Blue Green, Black, White Specify colour)	99.00	67.50	9KSA6-2PB 	Lockable key selector Actuator (2 Positions, maintained contact Key removable in both positions) - Black	360.00	297.00
9BA 	Booted Actuator (Yellow, Red, Blue Green, Black Specify colour)	135.00	108.00	9KSA6-2PL 	Lockable key selector Actuator (2 Positions, maintained contact Key removable in left position) - Black	360.00	297.00
9MA 	Mushroom Actuator (Spring Return) (Yellow, Red, Blue Green, Black Specify colour)	162.00	117.00	9KSA6-2PR 	Lockable key selector Actuator (2 Positions, maintained contact Key removable in right position) - Black	360.00	297.00
9MJA 	Jumbo Mushroom Actuator (Spring Return) (Red / Black Specify colour)	171.00	153.00	9KSA6-2PLSR 	Lockable key selector Actuator (2 Positions, spring return Key removable in left position) - Black	369.00	324.00
9MLA 	Stayput Mushroom Actuator (Press to lock and turn to release with arrow marking) (Red / Black Specify colour)	216.00	180.00	9KSA6-3PB 	Lockable key selector Actuator (3 Positions, maintained contact Key removable in both left & right positions) - Black	369.00	324.00
9MLAPP 	Stayput Mushroom Actuator (Press to lock and pull to release) (Red / Black Specify colour)	216.00	180.00	9KSA6-3PA 	Lockable key selector Actuator (3 Positions, maintained contact Key removable in all the three positions) - Black	369.00	324.00
9MJLA 	Jumbo Mushroom Actuator (Press to lock and turn to release with arrow marking) (Red / Black Specify colour)	252.00	225.00	9KSA6-3PL 	Lockable key selector Actuator (3 Positions, maintained contact Key removable in left position only) - Black	369.00	324.00



Colour code : Yellow-1, Red-2, Amber-3, Blue-4, Green-5, Black-6, White-7, Clear-8
 Contact Element Add on Screw type : JB1-1NO, JB2-1NC, JB3-2NO, JB4-2NC, JB5-2NO+2NC

Type & Description	M.R.P. Rs.	M.R.P. Rs.	Type & Description	M.R.P. Rs.	M.R.P. Rs.
	Metal	Plastic		Metal	Plastic
9KSA6-3PR  Lockable key selector Actuator (3 Positions,maintained contact Key removable in right position only) - Black	369.00	324.00	9SA6-3PSRL  Selector Actuator, 3 Positions (Center off, maintained contact on right, spring return from left to center)-Black	306.00	261.00
9KSA6-3PSR  Lockable key selector Actuator (3 Positions spring return on left & right positions.Key removable in center position only) - Black	378.00	351.00	9SA6-3PSRR  Selector Actuator, 3 Positions (Center off, maintained contact on left, spring return from right to center)-Black	306.00	261.00
9KSA6-3PSRL  Lockable key selector Actuator (3 Positions spring return from left to center.Maintained contact on right Key removable in center position only) - Black	378.00	351.00	9SEA6-2P  Selector Extended Actuator 2 Positions (Maintained contact)-Black	288.00	243.00
9KSA6-3PSRR  Lockable key selector Actuator (3 Positions spring return from right to center.Maintained contact on left Key removable in center position only) - Black	378.00	351.00	9SEA6-2PSR  Selector Extended Actuator 2 Positions (spring return from right to left)-Black	297.00	288.00
9SA6-2P  Selector Actuator, 2 Positions (Maintained contact)-Black	252.00	216.00	9SEA6-3P  Selector Extended Actuator 3 Positions (Maintained contact)-Black	306.00	261.00
9SA6-2P-SR  Selector Actuator, 2 Positions Spring return from right to left - Black	261.00	225.00	9SEA6-3PSR  Selector Extended Actuator 3 Positions (center off,both side spring return)-Black	315.00	288.00
9SA6-3P  Selector Actuator, 3 Positions (Maintained contact)-Black	297.00	252.00	9SEA6-3PSRL  Selector Extended Actuator 3 Positions (center off, maintained contact on right spring return from left to center)-Black	315.00	288.00
9SA6-3P-SR  Selector Actuator, 3 Positions (Center off-both sides spring return)-Black	306.00	261.00	9SEA6-3PSRR  Selector Extended Actuator 3 Positions (center off, maintained contact on left spring return from right to center)-Black	315.00	288.00
9LFA  Luminous Flush Actuator without series resistance with Filament Bulb suitable for operating at 110V,48V, and 24V, Yellow,Red,Amber,Blue, Green,White and Clear(Voltage and colour to be specified)	216.00	198.00	9LFAR  Luminous Flush Actuator with series resistance and with Filament Bulb suitable for 220V,110V,48V, and 24V, Yellow,Red,Amber,Blue, Green,White and Clear(Voltage and colour to be specified)	225.00	216.00
Colour code : Yellow-1,Red-2,Amber-3,Blue-4,Green-5,Black-6,White-7,Clear-8 Contact Element Add on Screw type : JB1-1NO, JB2-1NC, JB3-2NO, JB4-2NC, JB5-2NO+2NC					

Type & Description	M.R.P. Rs.	M.R.P. Rs.	Type & Description	M.R.P. Rs.	M.R.P. Rs.
	Metal	Plastic		Metal	Plastic
9LFA-L  Luminous Flush Actuator with Ultra bright LED, Yellow, Red, Amber, Green, Clear (AC or DC Voltage and colour to be specified)	288.00	243.00	9PL-L  Pilot light with Ultra bright LED, Blue and White (AC or DC Voltage and colour to be specified)	306.00	288.00
9LFA-L  Luminous Flush Actuator with Ultra bright LED, Blue and White (AC or DC Voltage and colour to be specified)	324.00	261.00	9LSA-2P  Luminous Selector Actuator, 2 Positions without series resistance with Filament Bulb suitable for operating at 110V, 48V, and 24V, Yellow, Red, Amber, Blue, Green, White and Clear (Voltage and colour to be specified)	369.00	351.00
9LPA  Luminous Projecting Actuator without series resistance with Filament Bulb suitable for operating at 110V, 48V, and 24V, Yellow, Red, Amber, Blue, Green, White and Clear (Voltage and colour to be specified)	216.00	198.00	9LSAR-2P  Luminous Selector Actuator, 2 Positions with series resistance with Filament Bulb suitable for operating at 220V, 110V, 48V, and 24V, Yellow, Red, Amber, Blue, Green, White and Clear (Voltage and colour to be specified)	378.00	360.00
9LPA-R  Luminous Projecting Actuator with series resistance and with Filament Bulb suitable for 220V, 110V, 48V, and 24V, Yellow, Red, Amber, Blue, Green, White and Clear (Voltage and colour to be specified)	225.00	216.00	9LSA-3P  Luminous Selector Actuator, 3 Positions without series resistance with Filament Bulb suitable for operating at 110V, 48V, and 24V, Yellow, Red, Amber, Blue, Green, White and Clear (Voltage and colour to be specified)	414.00	378.00
9LPA-L  Luminous Projecting Actuator with Ultra bright LED, Yellow, Red, Amber, Green, Clear (AC or DC Voltage and colour to be specified)	297.00	252.00	9LSAR-3P  Luminous Selector Actuator, 3 Positions with series resistance with Filament Bulb suitable for operating at 220V, 110V, 48V, and 24V, Yellow, Red, Amber, Blue, Green, White and Clear (Voltage and colour to be specified)	423.00	387.00
9LPA-L  Luminous Projecting Actuator with Ultra bright LED, Blue and White (AC or DC Voltage and colour to be specified)	351.00	288.00	9LSA-2P-L  Luminous Selector Actuator 2 Positions with Ultra bright LED, Yellow, Red, Amber, Green, Clear (AC or DC Voltage and colour to be specified)	387.00	297.00
9PL  Pilot light without series resistance with Filament Bulb suitable for operating at 110V, 48V, and 24V, Yellow, Red, Amber, Blue, Green, White and Clear (Voltage and colour to be specified)	171.00	153.00	9LSA-2P-L  Luminous Selector Actuator 2 Positions with Ultra bright LED, Blue and White (AC or DC Voltage and colour to be specified)	423.00	324.00
9PLR  Pilot light with series resistance and with Filament Bulb suitable for operating at 220V, 110V, 48V, and 24V, Yellow, Red, Amber, Blue, Green, White and Clear (Voltage and colour to be specified)	180.00	162.00	9LSA-2P-LSR  Luminous Selector Actuator 2 Positions spring return with Ultra bright LED, Yellow, Red, Amber, Green and Clear (AC or DC Voltage and colour to be specified)	414.00	306.00
9PL-L  Pilot light with Ultra bright LED, Yellow, Red, Amber, Green, Clear (AC or DC Voltage and colour to be specified)	261.00	243.00	9LSA-2P-LSR  Luminous Selector Actuator 2 Positions spring return with Ultra bright LED, Blue and White (AC or DC Voltage and colour to be specified)	423.00	324.00
Colour code : Yellow-1, Red-2, Amber-3, Blue-4, Green-5, Black-6, White-7, Clear-8 Contact Element Add on Screw type : JB1-1NO, JB2-1NC, JB3-2NO, JB4-2NC, JB5-2NO+2NC					

Type & Description		M.R.P. Rs. Metal	M.R.P. Rs. Plastic	Type & Description	M.R.P. Rs. Metal	M.R.P. Rs. Plastic
9LSA-3P-L 	Luminous Selector Actuator 3Positions with Ultra bright LED, Yellow,Red,Amber,Green,Clear (AC or DC Voltage and colour to be specified)	414.00	306.00	9LTA2-5 	288.00	243.00
9LSA-3P-L 	Luminous Selector Actuator 3Positions with Ultra bright LED, Blue and White (AC or DC Voltage and colour to be specified)	441.00	351.00	9LTAR2-5 	306.00	288.00
9TA2-5 	Twin Actuator with flush green button marked with "I" flush red button marked with "O"	180.00	162.00	9LTA-2-5-L 	360.00	306.00

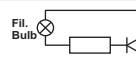
Sr.No.	Basic Switch	Type Nos. & Combination		Assembly Ref Fig. No.	Diagram
		Act. Mounting	Ind. Mounting		
1	1 NO	JB 1		1	σσ
2	1 NO		JB 5	6	σσ
3	1 NC	JB 2		1	σσ
4	1 NC		JB 6	6	σσ
5	1 NO + 1NC	JB 1 + JB 2		2 or 3	σσ σσ
6	1 NO + 1NC		JB 5 + JB 6	7	σσ σσ
7	2 NO	JB 1 + JB 1		2 or 3	σσ σσ
8	2 NO		JB 5 + JB 5	7	σσ σσ
9	2 NC	JB 2 + JB 2		2 or 3	σσ σσ
10	2 NC		JB 6 + JB 6	7	σσ σσ
11	2 NO + 2 NC	JB 1 + JB 1 JB 2 + JB 2		4	σσ σσ σσ σσ
12	3 NO + 3 NC	JB 1 + JB 1 + JB 1 JB 2 + JB 2 + JB 2		5	σσ σσ σσ σσ σσ σσ

Ordering examples of illuminated items				
RESISTANCE + DIODE (Res)		Voltage AC/DC		
		Item examples & type no		
		24V	Pilot light YELLOW	9PLR1-24
		48V	Sel. Act. 2 Pos. RED	9LSAR2-2P48
DIRECT (No Res)		Voltage AC/DC		
		Item examples & type no		
		24V	Pilot light GREEN	9PL5-24
LED	To order illuminated actuators or pilot lights with LED, Please add/suffix L to above type nos with resistance and supply voltage AC/DC. Eg. 9LFA5-L24DC OR 9PL2-L-230AC.			





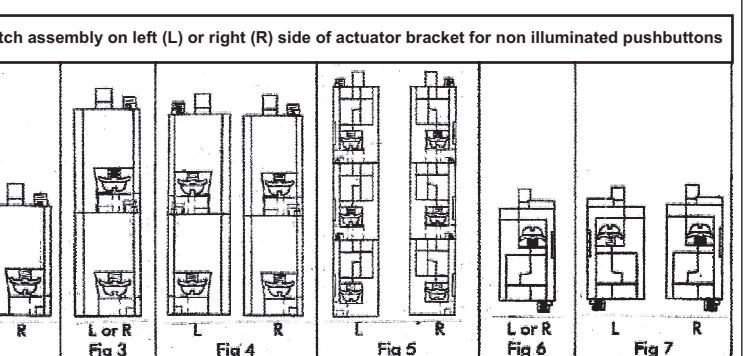
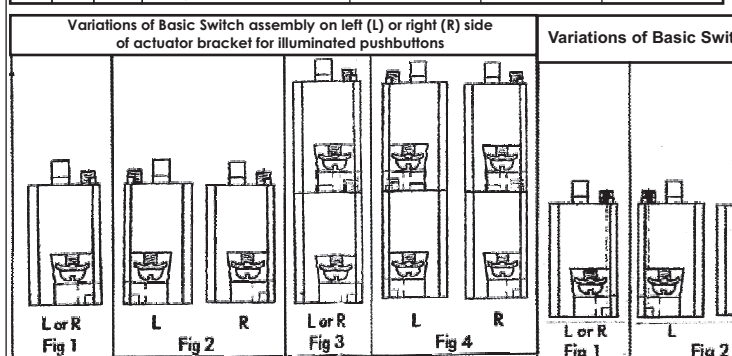





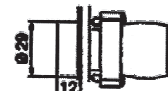

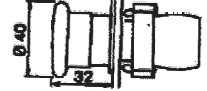
Sr.No.	Function	Key Removable			Type Nos. Key / Selector
		Left	Center	Right	
1	Stayput	x		x	9KSA6-2PB
2	Stayput	x			9KSA6-2PL
3	Stayput			x	9KSA6-2PR
4	Spring return	x			9KSA6-2PLSR
5	Stayput	x		x	9KSA6-3PB
6	Stayput	x	x	x	9KSA6-3PA
7	Stayput		x		9KSA6-3P
8	Spring return		x		9KSA6-3PSR
9	Spring return		x		9KSA6-3PSRL
10	Spring return		x		9KSA6-3PSRR
					Selector Selector Extd
11	Stayput				9SA6-2P 9SEA6-2P
12	Spring return				9SA6-2PSR 9SEA6-2PSR
13	Stayput				9SA6-3P 9SEA6-3P
14	Spring return				9SA6-3PSR 9SEA6-3PSR
15	Spring return				9SA6-3PSRL 9SEA6-3PSRL
16	Spring return				9SA6-3PSRR 9SEA6-3PSRR

TECHNICAL SPECIFICATIONS:	
Approvals	: Bureau of Indian Standards, CSA International, Canada / US
Standards Conformity	: IS/IEC 60947 (part 5/ Sec.I)
Degree of Protection	: IP 65
Rated Insulation voltage	: 600v
Rated thermal current	: 10A
Contact operation	: Self wiping, slow break NO or NC
Make and break capacity	: AC 15, 5A, 240 VAC DC 13, 1.1A, 250 VDC
As per IEC 947-5-(1) 2000	
Terminal marking	: 1-2 for NC, 3-4 for NO
Terminal capacity	: Maximum 2 x 1.5mm ² or 1 x 2.5 mm ² Minimum 1 x 0.5mm ²
Short Circuit Protection	: 10 A cartridge fuse HRC type, rated for resistive loading
Operating Temperature	: -25°C + 70°C
Altitude	: <3000 m
Mechanical Life	: Over 1 million operations.

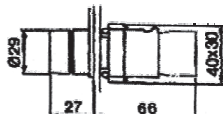
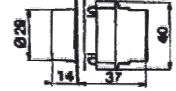

The above are some mounting arrangements for a maximum number of four basic switch for illuminated pushbuttons. The above are some mounting arrangements for a maximum of six basic switches for non - illuminated pushbuttons

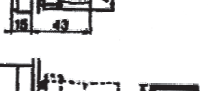
TYPES OF LED ILLUMINATED PILOT LIGHTS • PUSH BUTTONS • SELECTOR SWITCHES Ø22.5mm

DESCRIPTION		TYPE OF ACTUATOR OR LENSE ASSEMBLY	COLOUR OF ACTUATOR OR LENSE	BASIC SWITCHES NO=JB1, NC=JB2 OR LAMP HOLER	TYPE OF COMPLETE PUSH BUTTON
FLUSH PUSHBUTTON		9FA5 9FA2	GREEN RED	1NO 2NO+1NC	9PBF5-10 9PBF2-21
PROJECTING PUSHBUTTON		9PA6 9PA2	BLACK RED	2NC 3NO+3NC	9PBP6-02 9PBP2-33
BOOTED PUSHBUTTON		9BA2 9BA5	RED GREEN	2NO 2NC	9PBB2-20 9PBB5-02
MUSHROOM PUSHBUTTON SPRING RETURN		9MA6 9MA2	BLACK RED	1NO+1NC 1NC	9PBM6-11 9PBM2-01
MUSHROOM PUSHBUTTON LATCHING, TURN TO RELEASE		9MLA6 9MLA2	BLACK RED	1NC 2NO+2NC	9PML6-01 9PML2-22
MUSHROOM PUSHBUTTON LATCHING, KEY TO RELEASE		9MLKA2	RED	1NO+1NC	9PMLK2-11
SELECTOR ACTUATOR(2 POS) SELECTOR ACTUATOR(3 POS)		9SA6-2P 9SA6-3P	BLACK BLACK	1NO 1NO+1NC	9PBS6-10-2P 9PBS6-11-3P
KEY SELECTOR ACTUATOR (2POS), KEY WITHDRAWABLE IN BOTH POSITIONS KEY ACTUATOR (3POS) KEY WITHDRAWABLE IN LEFT AND RIGHT POSITION		9KSA6-2P 9KSA6-3P	BLACK BLACK	1NO 1NO+1NC	9PBKS6-10-2P 9PBKS6-11-3P
SELECTOR LUMINOUS PUSHBUTTON, 2 POSITION WITH RESISTANCE AND DIODE (230V) SELECTOR LUMINOUS PUSHBUTTON, 3 POSITION WITH RESISTANCE AND DIODE (24V)		9LSAR5-2P230 9LSAR2-3P24	GREEN RED	1NO+1NC+ 9LHR230 1NO+1NC+ 9LHR24	9PBLSR5-11-2P-230 9PBLSR2-11-3P-24
PILOT LIGHT FOR DIRECT CONNECTION		9PL5 9PL2	GREEN RED	9LHB130 9LHB130	9PBPL5-130 9PBPL2-130
PILOT LIGHT THROUGH RESISTOR AND DIODE FOR 230V. BULB:130V		9PLR 3 9PLR 4	AMBER BLUE	9LHR230 9LHR230	9PBPLR3-230 9PBPLR4-230
LUMINOUS PROJ. PUSHBUTTON DIRECT CONNECTION FOR 24V LUMINOUS PROJ. PUSHBUTTON PUSH-PUSH TYPE DIRECT CONNECTION(130V)		9LPA5 9LPPA2-130	GREEN PROJ-RED	1NO+1NC+ 9LHB24 1NO+1NC+ 9LHB130	9PBP5-11-24 9PBLPP2-11-130
LUMINOUS FLUSH PUSHBUTTON THROUGH RESISTOR AND DIODE FOR 230V BULB:130V		9LFR2-230	RED	1NO+1NC+	9PBLFR2-11-230
NON-ILLUMINATED TWIN PUSHBUTTON ACTUATOR MARKED "1- O"		9TA2-5	FLUSH GREEN	1NO + 1NC	9PBT2-5-11
TWIN PUSHBUTTON NOT MARKED FLUSH PROJECTING		9TA5-2	FLUSH GREEN	1NO 1NC	9PBT5-2-11
LUMINOUS TWIN PUSHBUTTON MARKED "1 O" FLUSH FLUSH		9LTA5F2 F2 IO 130	LENSE-AMBER FLUSH-GREEN FLUSH-RED	9LHB130 1NO+1NC	9PBLT2-5-11-130
LUMINOUS TWIN PUSHBUTTON NOT MARKED FLUSH PROJECTING WITH RESISTANCE AND DIODE (230V)		9LTAR3-F5 -P2-230	LENSE-AMBER FLUSH-GREEN PROJ-RED	9LHBR230 1NO 1NC	9PBLTR3-F5-10-FP2-01- 230

ACCESSORIES AND SPARES

Contact Element



Type	Contacts	Normal
JB 1	1 NO	67.50
JB 2	1 NC	67.50

9ALP
MRP Rs. 40.50



Adapter for assembly of 22.5mm dia control gear in 30.5mm dia cutout **9AA** MRP Rs.40.50

LEGEND PLATES

Legend Plates 30 X 40 mm are supplied with the following standard texts:

START FORWARD UP OPEN AUTO SLOW RESET
STOP REVERSE DOWN CLOSE HAND FAST INCH

Legend plate Ø 60 mm yellow with black characters for EMERGENCY STOP

BULBS

Filament Bulbs type **JLBC27S**

Voltage :	6	12	24	30	48	60	130
Watts :	1	2	2	2	2	2	2.6

JLBC27S
MRP Rs. 40.50



LENSES

9PLL / 9LAL MRP Rs. 40.50

Colour of Lense:	YELLOW	RED	AMBER	BLUE	GREEN	TRANSLUCENT	CLEAR
For Pilot Lights	9PLL1	9PLL2	9PLL3	9PLL4	9PLL5	9PLL7	9PLL8
For Luminous Actuators (Flush / projecting)	9LAL1	9LAL2	9LAL3	9LAL4	9LAL5	9LAL7	9LAL8
For Twin Luminous Actuators	9LTAL1	9LTAL2	9LTAL3	9LTAL4	9LTAL5	9LTAL7	9LTAL8



9TAL MRP Rs. 31.50

BULB EXTRACTOR

Type No : **9JLBC27SE**



BLANKING PLUG FOR Ø 22.5mm HOLE, BLACK

Type No : **9BP6**

9BP6
MRP Rs. 40.50



RUBBER BOOTS FOR BOOTED ACTUATORS

Colour of Boot :	YELLOW	RED	BLUE	GREEN	BLACK
Type No :	9RB1	9RB2	9RB4	9RB5	9RB6

9RB
MRP Rs. 40.50



PADLOCK

Padlock for mushroom actuator
Padlock for projecting actuator



ORDERING INSTRUCTIONS

Actuators, Illuminated Actuators, Basic Switches, Lense Assemblies and Pilot Lights can all be ordered separately or in combination. Code No. of Illuminated Actuators and Non-illuminated Actuators colours are given in colour chart.

Type of Basic Switches : NO : Actuator mounting : JB1, Individual mounting : JB5.
NC : Actuator mounting : JB2, Individual mounting : JB6.

Example of Push Button : Type 9PBF211 means flush pushbutton, RED with 1NO + 1NC Basic Switches,

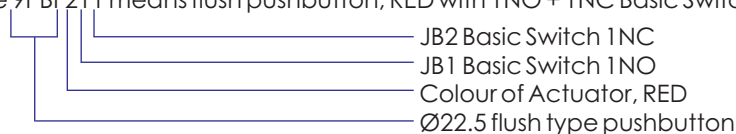

Engineering Plastic PUSH BUTTON STATION BOXES CATALOGUE CUM PRICE LIST

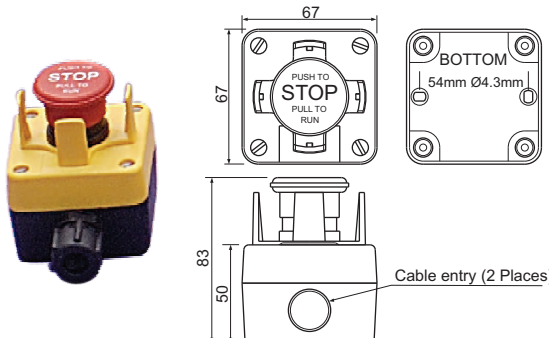
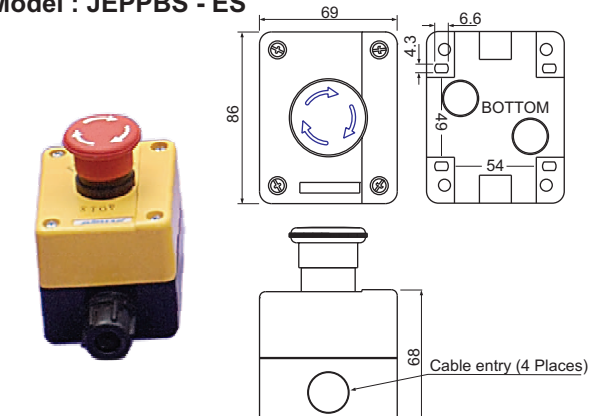
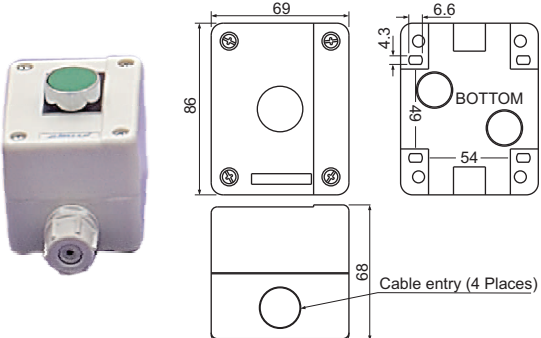
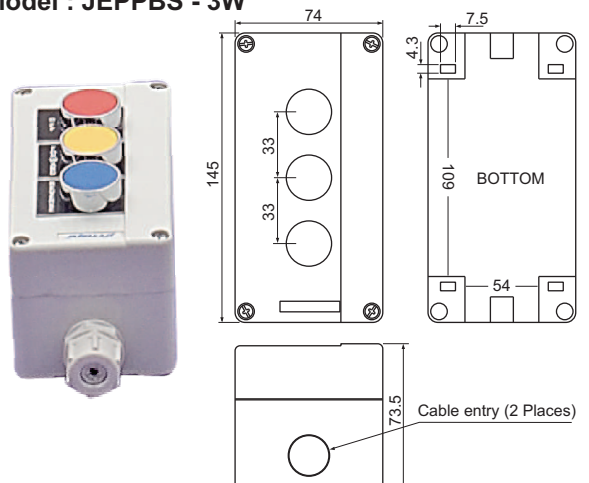
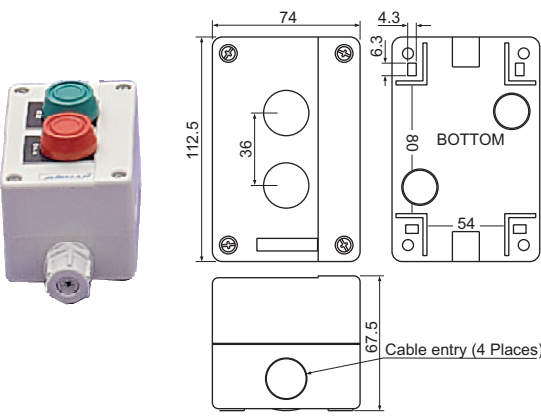
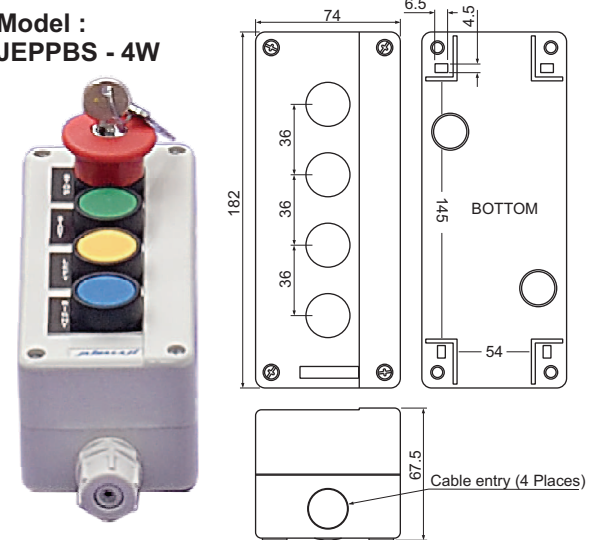
<p>Model : JEPBBS - PG</p> 	<p>M.R.P.</p> <p>Box Only Rs.297</p> <p>Box with 9MLA2 +JB1+JB2 Rs.639</p>	<p>Model : JEPBBS - ES</p> 	<p>M.R.P.</p> <p>Box Only Rs.324</p> <p>Box with 9MLA2 +JB1+JB2 Rs.639</p>
<p>Model : JEPBBS - 1W</p> 	<p>Box Only Rs.288</p> <p>Box with 9FA +JB1+JB2 Rs.477</p>	<p>Model : JEPBBS - 3W</p> 	<p>Box Only Rs.450</p> <p>Box with 9FA (3Nos) +3JB1 +3JB2 Rs.1026</p>
<p>Model : JEPBBS - 2W</p> 	<p>Box Only Rs.369</p> <p>Box with 9FA (2Nos) +2JB1 +2JB2 Rs.756</p> <p>Box with Actuator &Element</p>	<p>Model : JEPBBS - 4W</p> 	<p>Box Only Rs.522</p> <p>Box with 9MLKA2 +9FA (3) +4JB1 +4JB2 Rs.1530</p> <p>Box with Actuator &Element</p>
<p>Model : JEPBBS - 5W (Five way)</p> <p>Rs.639</p>	<p>Rs.1620</p>	<p>Model : JEPBBS - 8W (Eight way)</p> <p>Rs.873</p>	<p>Rs.2430</p>
<p>Model : JEPBBS - 6W (Six way)</p> <p>Rs.756</p>	<p>Rs.1926</p>		

JAIBALAJI
CONTROL GEARS PVT. LTD

Post Box No. 27, 89 (New No. 107),SIDCO Industrial Estate,Ambattur, Chennai -600 098. India
Phone: +91 44 26251279 / 26257859 / 26254470 Fax: +91 44 26255038.
E-mail: dchandramohan@jaibalaji.firm.in Web: jaibalaji.in

PLASTIC PENDENT PUSH BUTTON STATION BOXES CATALOGUE CUM PRICE LIST

*Price without
Actuator & Contact
element*



Model		M.R.P. Rs.
JPPPBS 2W	Two Way	1404
JPPPBS 3W	Three Way	2124
JPPPBS 4W	Four Way	2268
JPPPBS 5W	Five Way	2988
JPPPBS 6W	Six Way	3285
JPPPBS 8W	Eight Way	3672
JPPPBS 9W	Nine Way	3888
JPPPBS 10W	Ten Way	4860
JPPPBS 11W	Eleven Way	5229
JPPPBS 12W	Twelve Way	5508
JPPPBS 13W	Thirteen Way	5832
JPPPBS 14W	Fourteen Way	6156

ALUMINIUM PUSH BUTTON STATION BOXES

ALUMINIUM PENDENT PUSH BUTTON STATION BOXES

CATALOGUE CUM PRICE LIST

ALUMINIUM PUSH BUTTON STATION BOXES



PRICE WITH PLASTIC ACTUATOR & CONTACT ELEMENTS(NO & NC)

Model		M.R.P. Rs.
JAPBS 1W	One Way	810
JAPBS 1W D	Double Element	1188
JAPBSK 1W	One way Kanopi	801
JAPBS 2W	Two Way	1134
JAPBS 2W D	Double Element	1494
JAPBSK 2W	Two way Kanopi	1431
JAPBS 3W	Three Way	1332
JAPBS 3W D	Double Element	1881
JAPBSK 3W	Three way Kanopi	1458
JAPBS 4W	Four Way	1647
JAPBS 6W	Six Way	2304
JAPBS 8W	Eight Way	3042
JAPBS 10W	Ten Way	3618
JAPBS 12W	Twelve Way	4284
JAPBS 14W	Fourteen Way	5022

ALUMINIUM PENDENT PUSH BUTTON STATION BOXES



PRICE WITH PLASTIC ACTUATOR & CONTACT ELEMENTS(NO & NC)

Model		M.R.P. Rs.
JAPPBS 1W	One Way	864
JAPPBS 2W	Two Way	1188
JAPPBS 3W	Three Way	1386
JAPPBS 4W	Four Way	1710
JAPPBS 5W	Five Way	1971
JAPPBS 6W	Six Way	2358
JAPPBS 7W	Seven Way	2727
JAPPBS 8W	Eight Way	3096
JAPPBS 9W	Nine Way	3312
JAPPBS 10W	Ten Way	3780
JAPPBS 12W	Twelve Way	4590
JAPPBS 14W	Fourteen Way	5220
JAPPBS 16W	Sixteen Way	6228
JAPPBS 18W	Eighteen Way	6795
JAPPBS 20W	Twenty Way	7848
JAPPBS 22W	Twenty Two Way	8397

ALUMINIUM PUSH BUTTON STATION BOXES ALUMINIUM PENDENT PUSH BUTTON STATION BOXES CATALOGUE CUM PRICE LIST

Price without
Actuator & Contact
element

ALUMINIUM PUSH BUTTON STATION BOXES



Model		M.R.P. Rs.
JAPBS 1W	One Way	378
JAPBS 1W D	Double Element	576
JAPBSK 1W	One way Kanopi	468
JAPBS 2W	Two Way	576
JAPBS 2W D	Double Element	648
JAPBSK 2W	Two way Kanopi	594
JAPBS 3W	Three Way	594
JAPBS 3W D	Double Element	693
JAPBSK 3W	Three way Kanopi	720
JAPBS 4W	Four Way	693
JAPBS 6W	Six Way	810
JAPBS 8W	Eight Way	954
JAPBS 10W	Ten Way	1116
JAPBS 12W	Twelve Way	1530
JAPBS 14W	Fourteen Way	1656

ALUMINIUM PENDENT PUSH BUTTON STATION BOXES



Model		M.R.P. Rs.
JAPPBS 1W	One Way	423
JAPPBS 2W	Two Way	621
JAPPBS 3W	Three Way	639
JAPPBS 4W	Four Way	738
JAPPBS 5W	Five Way	756
JAPPBS 6W	Six Way	864
JAPPBS 7W	Seven Way	990
JAPPBS 8W	Eight Way	1116
JAPPBS 9W	Nine Way	1233
JAPPBS 10W	Ten Way	1431
JAPPBS 12W	Twelve Way	1746
JAPPBS 14W	Fourteen Way	1944
JAPPBS 16W	Sixteen Way	2484
JAPPBS 18W	Eighteen Way	2574
JAPPBS 20W	Twenty Way	2835
JAPPBS 22W	Twenty two Way	3267



ISO 9001:2015 Certified

RECOGNITION OF *Quality Plus*

Engineering Plastic **JUNCTION BOXES** and **DISTRIBUTION BOXES** (Made of ABS / Polycarbonate)

CATALOGUE CUM PRICE LIST



JEPJB 200



JEPJB 200



JEPJB 200



JEPJB 200



AC Box



JEPJB 200



JEPJB 200



JEPJB 200



JEPJB 200



JEPJB 200

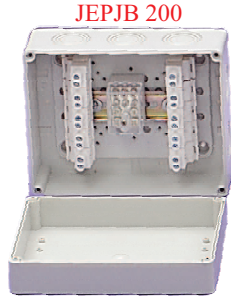

JEPJB 200



JEPJB 200



JEPJB 200

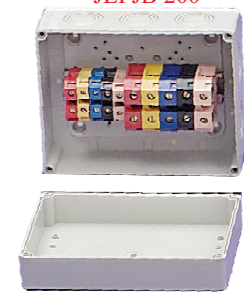

JEPJB 200



JEPJB 140

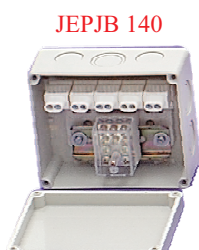

JEPJB 140



JEPJB 140

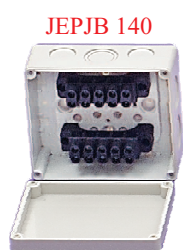

JEPJB 140



JEPJB 140



JEPJB 96

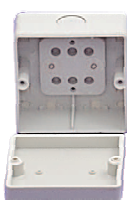

JEPJB 96

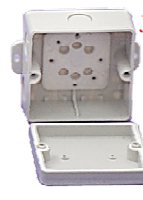

JEPJB 86

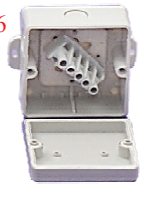

JEPJB 86

M.R.P. Rs.288

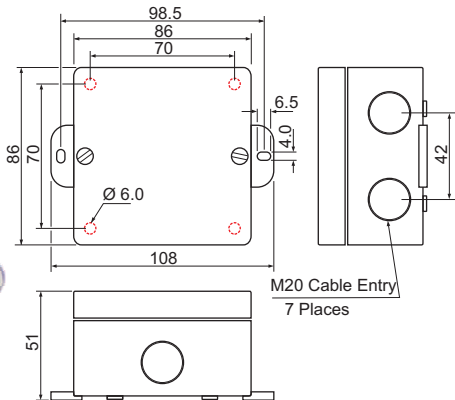

JEPJB 96

M.R.P. Rs.414

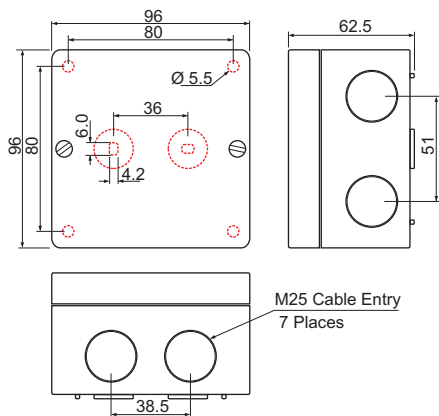

JEPJB 140

M.R.P. Rs.567

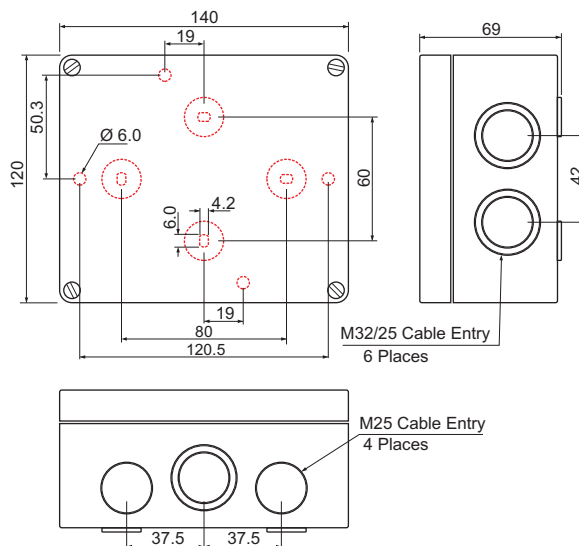

JEPJB 200

M.R.P. Rs.972

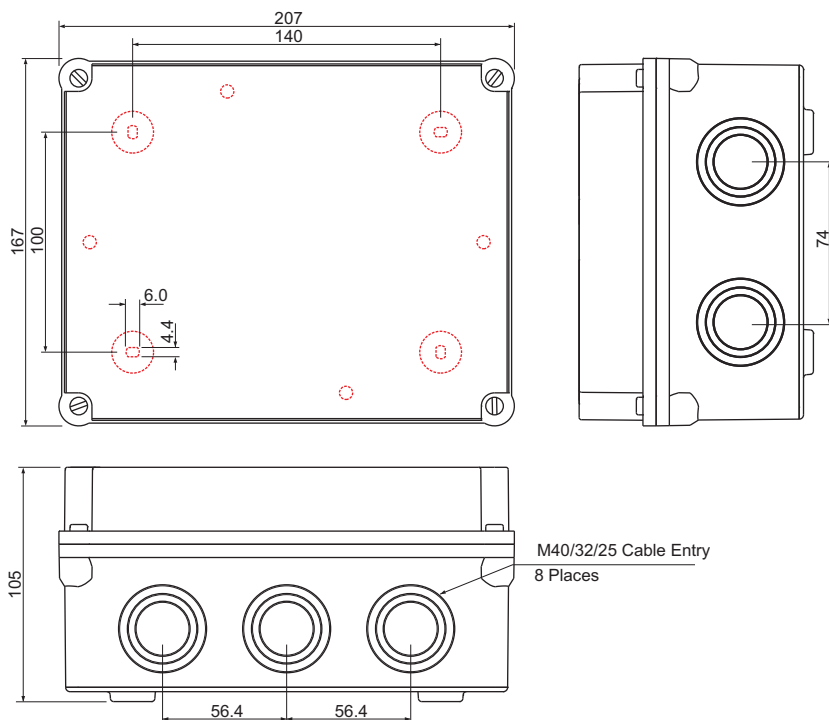

JEPJB 265

M.R.P. Rs.1854

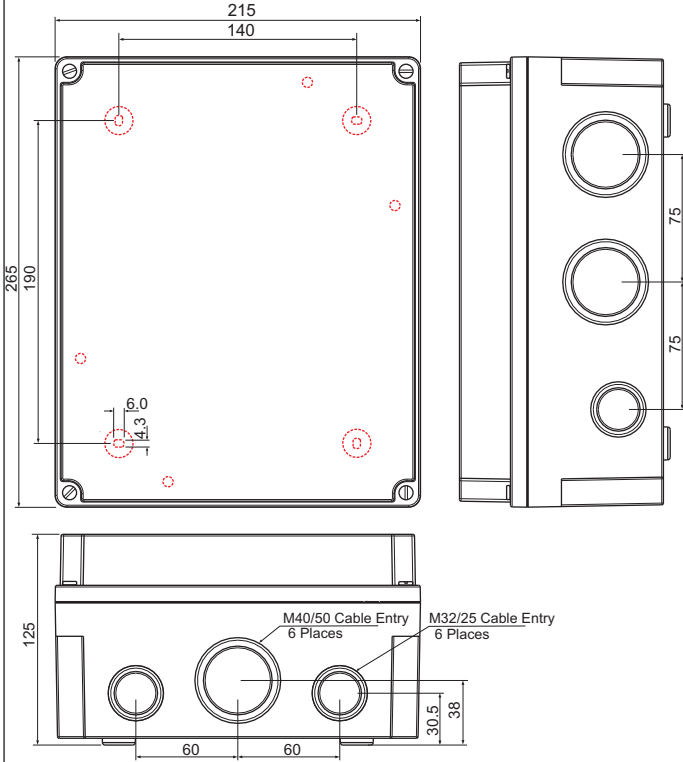

JEPJB 320

M.R.P. Rs.3150

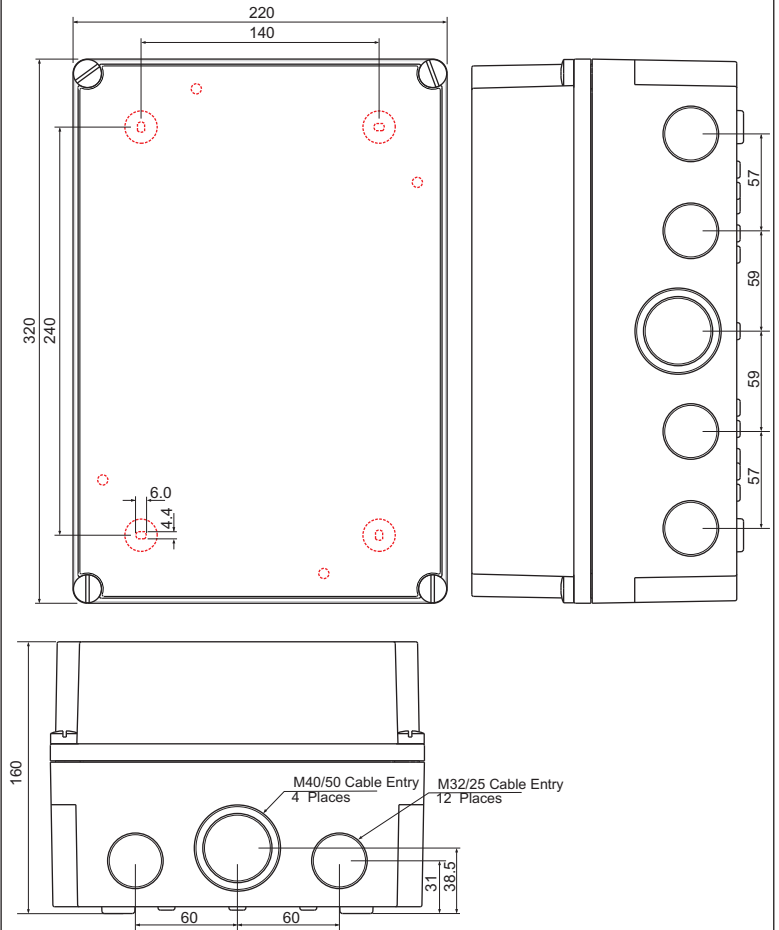

JEPJB 300

M.R.P. Rs.3285

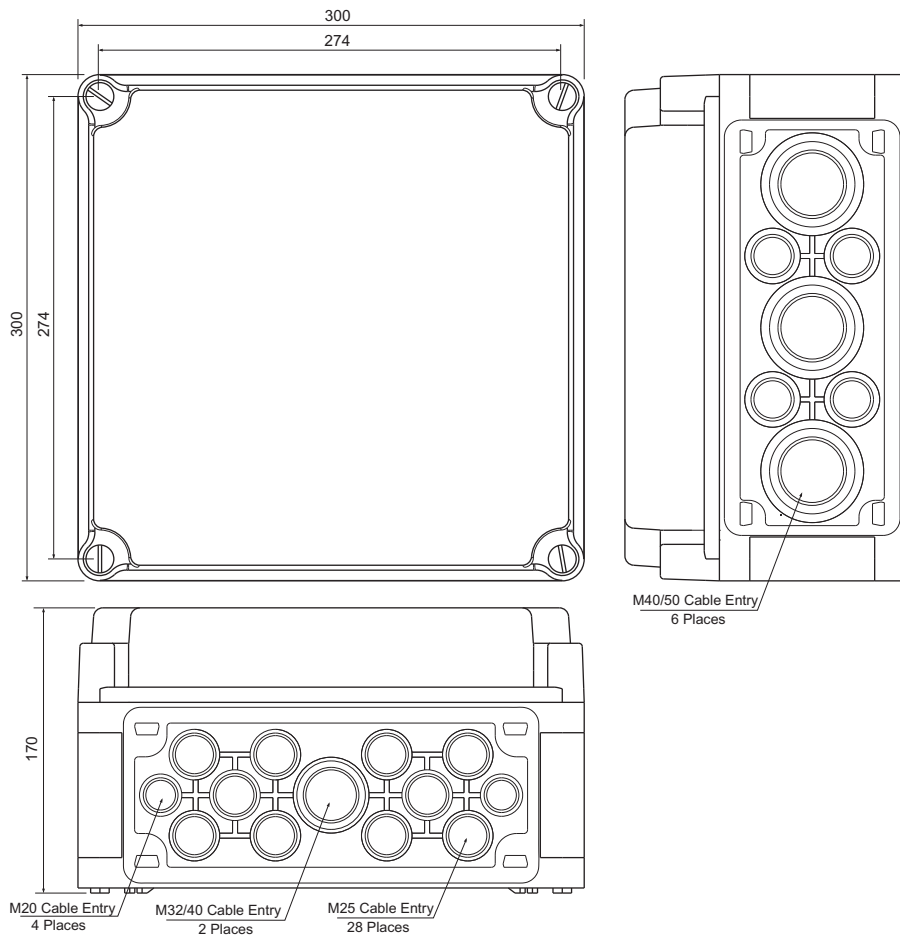

Some Combinations of Distribution Boxes

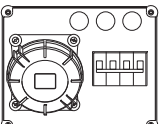
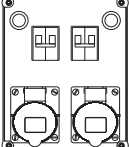
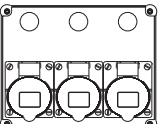
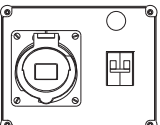
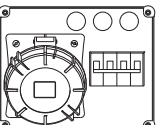
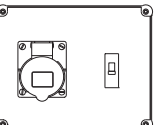
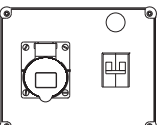
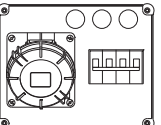
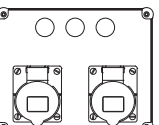
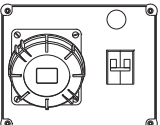
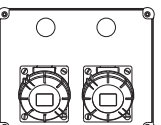
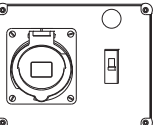
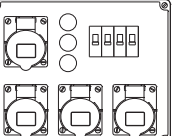
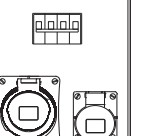
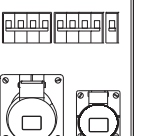
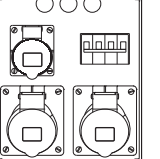
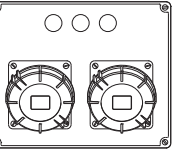
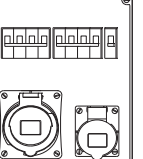
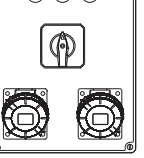
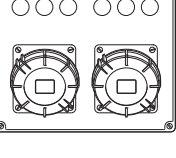
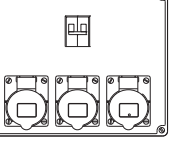
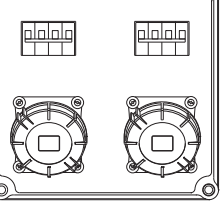
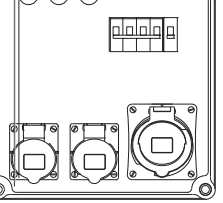
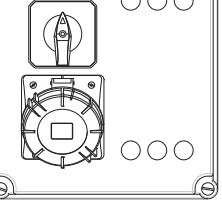
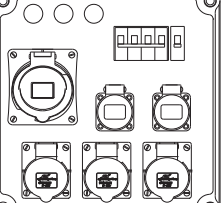
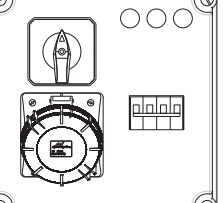
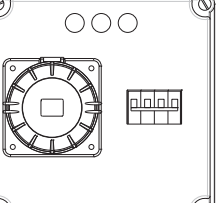
<p>DB216-35 MI Drawing No. AS052 JEPJB200 - BOX 32 Amps 3Pin+Earth+Neutral Angled Socket IP-67 &Indicator Provision for 4 Pole MCB</p> 	<p>DB216-133 MI Drawing No. AS047 JEPJB200 - BOX 16 Amps 2Pin+Earth Angled Socket IP-44 &Indicator Provision for 2x2 Pole MCB</p> 	<p>DB216-1333 I Drawing No. AS054 JEPJB200 - BOX 16 Amps 2Pin+Earth Angled Socket IP-44 (3 Nos) &Indicator</p> 
<p>DB216-33 MI Drawing No. AS059 JEPJB200 - BOX 32 Amps 2Pin+Earth Angled Socket IP-44 &Indicator Provision for 2 Pole MCB</p> 	<p>DB216-65 MI Drawing No. AS065 JEPJB200 - BOX 63 Amps 3Pin+Earth+Neutral Angled Socket IP-67 &Indicator Provision for 4 Pole MCB</p> 	<p>DB216-13 M Drawing No. AS133 JEPJB200 - BOX 16 Amps 2Pin+Earth Angled Socket IP-44 &Indicator Provision for 1 Pole MCB</p> 
<p>DB216-13 MI Drawing No. AS060 JEPJB200 - BOX 16 Amps 2Pin+Earth Angled Socket IP-44 &Indicator Provision for 2 Pole MCB</p> 	<p>DB216-15 MI Drawing No. AS098 JEPJB200 - BOX 16 Amps 3Pin+Earth+Neutral Angled Socket IP-67 &Indicator Provision for 4 Pole MCB</p> 	<p>DB216-133 I Drawing No. AS142 JEPJB200 - BOX 16 Amps 2Pin+Earth Angled Socket IP-44 (2Nos) &Indicator</p> 
<p>DB216-33 MI Drawing No. AS061 JEPJB200 - BOX 32 Amps 2Pin+Earth Angled Socket IP-67 &Indicator Provision for 2 Pole MCB</p> 	<p>DB216-133 I Drawing No. AS112 JEPJB200 - BOX 16 Amps 2Pin+Earth Angled Socket IP-67 (2 Nos) &Indicator</p> 	<p>DB216-33 MI Drawing No. AS149 JEPJB200 - BOX 32 Amps 2Pin+Earth Angled Socket IP-44 &Indicator Provision for 1 Pole MCB</p> 
<p>Drawing No. AS051 JEPJB265 - BOX 16 Amps 2Pin+Earth Angled Socket IP-44(4 Nos) &Indicator Provision for 4x1 Pole MCB</p> 	<p>Drawing No. AS113 JEPJB265 - BOX 32 Amps 3Pin+Earth+Neutral Angled Socket IP-44 16 Amps 2Pin+Earth Angled Socket IP-44 Provision for 4 Pole MCB</p> 	<p>Drawing No. AS131 JEPJB265 - BOX 16 Amps 3Pin+Earth+Neutral Angled Socket IP-44 16 Amps 2Pin+Earth Angled Socket IP-44 Provision for 4+4+1 Pole MCB</p> 
<p>Drawing No. AS067 JEPJB265 - BOX 16 Amps 3Pin+Earth+Neutral Angled Socket IP-44(2 Nos) 16 Amps 2Pin+Earth Angled Socket IP-44 &Indicator Provision for 4 Pole MCB</p> 	<p>Drawing No. AS115 JEPJB265 - BOX 32 Amps 3Pin+Earth Angled Socket IP-67(2Nos) Indicator</p> 	<p>Drawing No. AS132 JEPJB265 - BOX 32 Amps 3Pin+Earth+Neutral Angled Socket IP-44 Provision for 4+4+1 Pole MCB</p> 
<p>Drawing No. AS106 JEPJB265 - BOX 16 Amps 2Pin+Earth Angled Socket IP-67(2 Nos) &Indicator Rotary switch 32A P No.27197</p> 	<p>Drawing No. AS116 JEPJB265 - BOX 32 Amps 3Pin+Earth Angled Socket IP-44(2Nos) Indicator</p> 	<p>Drawing No. AS135 JEPJB265 - BOX 16 Amps 2Pin+Earth Angled Socket IP-44(3 Nos.) Provision for 2 Pole MCB</p> 
<p>Drawing No. AS019 JEPJB300 - BOX 32 Amps 3Pin+Earth +Neutral Angled Socket IP-67 (2 Nos) Provision for 4+4 Pole MCB</p> 	<p>Drawing No. AS049 JEPJB300 - BOX 32 Amps 3Pin+Earth +Neutral Angled Socket IP-44 16 Amps 2Pin+Earth Angled Socket IP-44 (2 Nos.) &Indicator Provision for 4+1 Pole MCB</p> 	<p>Drawing No. AS063 INTERLOCK BOX JEPJB300 - BOX 63 Amps 3Pin+Earth +Neutral Angled Socket IP-67 63 Amps Rotary Switch Program No.27004 LED Indicator 6</p> 
<p>Drawing No. AS048 32 Amps 3Pin+Earth +Neutral Angled Socket IP-44 16 Amps 2Pin+Earth Angled Socket IP-44 (3 Nos.) 16 Amps 2Pin Straight Socket IP-44 (2 Nos.) &Indicator Provision for 4+1 Pole MCB</p> 	<p>Drawing No. AS057 INTERLOCK BOX JEPJB300 - BOX 63 Amps 3Pin+Earth +Neutral Angled Socket IP-67 63 Amps Rotary Switch Program No.27004 LED Indicator 3 Provision for 4 Pole MCB</p> 	<p>Drawing No. AS090 JEPJB300 - BOX 125 Amps 3Pin+Earth +Neutral Straight Socket IP-67 & Indicator Provision for 4 Pole MCB</p> 

Some Combinations of Junction Box With Sockets

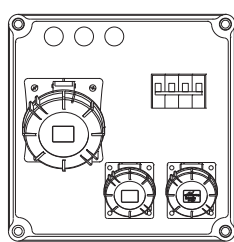

Drawing No. AS104
JEPJB300 - BOX
63 Amps 3Pin+Earth+Neutral Angular Socket IP-67
16 Amps 2Pin+Earth Angled Socket IP-67 & Indicator
Provision for 4 Pole MCB

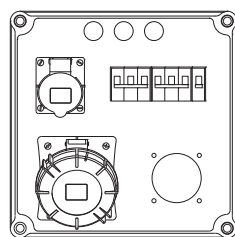

Drawing No. AS137
JEPJB300 - BOX
63 Amps 3Pin+Earth+Neutral Angular Socket IP-67
16 Amps 2Pin+Earth Angled Socket IP-67 & Indicator
Provision for 32 Amps 3Pin+Earth+Neutral Straight Socket IP-44
Provision for 3+3+1 Pole MCB

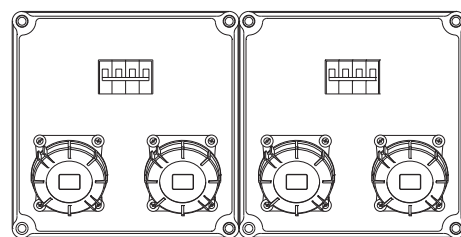

Drawing No. AS094
JEPJB300 - BOX - 2 Nos.
32 Amps 3Pin+Earth+Neutral Angular Socket IP-67 (4 Nos)

Provision for 4 Pole MCB

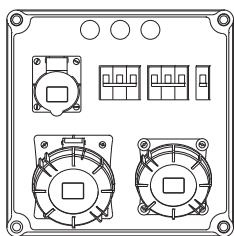

Drawing No. AS121
JEPJB300 - BOX
63 Amps 3Pin+Earth+Neutral Angular Socket IP-67
32 Amps 3Pin+Earth+Neutral Angular Socket IP-67
16 Amps 2Pin+Earth Angled Socket IP-44 & Indicator

Provision for 3+3+1 Pole MCB

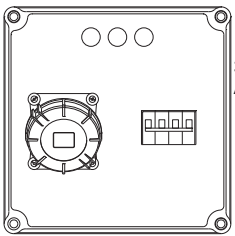

Drawing No. AS157
JEPJB300 - BOX
32 Amps 3Pin+Earth+Neutral Angular Socket IP-67 & Indicator
Provision for 4 Pole MCB

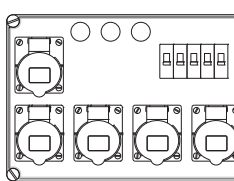

Drawing No. AS050
JEPJB320 - BOX
16 Amps 2Pin+Earth Angled Socket IP-44 (5 Nos.) & Indicator

Provision for 5 single Pole MCB

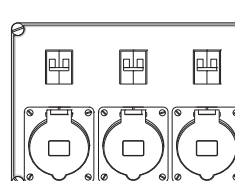

Drawing No. AS097
JEPJB320 - BOX
32 Amps 2Pin+Earth Angled Socket IP-44 (3 Nos.)

Provision for 3 Two Pole MCB

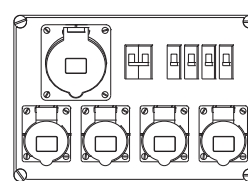

Drawing No. AS082
JEPJB320 - BOX
32 Amps 2Pin+Earth Angled Socket IP-44
16 Amps 2Pin+Earth Angled Socket IP-44 (4 Nos.)

Provision for 2+1+1+1 Pole MCB

JEPJB140 - BOX

J635BMAS IP- 44
63 Amps 3Pin+Earth+Neutral Angled Socket (IP-44)
M.R.P. Rs.4842

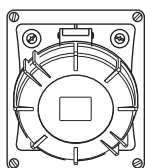

J635BMAS IP- 67
63 Amps 3Pin+Earth+Neutral Angled Socket (IP-67)
M.R.P. Rs.5103

JEPJB86 - BOX

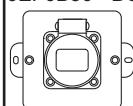

J162BMSS IP- 44
16 Amps 2Pin Straight Socket
M.R.P. Rs.783

JEPJB96 - BOX

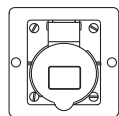

J203BMSS IP- 44
16 Amps 2Pin+Earth Straight Socket
M.R.P. Rs.1188

J203BMAS IP- 44
16 Amps 2Pin+Earth Angled Socket
M.R.P. Rs.1161

J203BMAS IP- 67
16 Amps 2Pin+Earth Angled Socket
M.R.P. Rs.1260

J323BMAS IP- 44
32 Amps 2Pin+Earth Angled Socket
M.R.P. Rs.1818

JEPJB140 - BOX

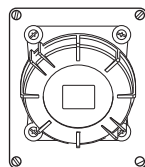

J323BMAS IP- 67
32 Amps 2Pin+Earth Angled Socket
M.R.P. Rs.1935

J324BMAS IP- 44
32 Amps 3Pin+Earth Angled Socket
M.R.P. Rs.1917

J324BMAS IP- 67
32 Amps 3Pin+Earth Angled Socket
M.R.P. Rs.2034

J325BMAS IP- 44
32 Amps 3Pin+Earth+Neutral Angled Socket M.R.P. Rs.1980

J325BMAS IP- 67
32 Amps 3Pin+Earth+Neutral Angled Socket M.R.P. Rs.2079

JEPJB140 - BOX

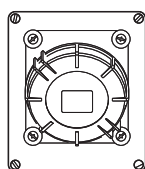

J205BMSS IP- 44
16 Amps 3Pin+Earth+Neutral Straight Socket M.R.P. Rs.1746

J205BMSS IP- 67
16 Amps 3Pin+Earth+Neutral Straight Socket M.R.P. Rs.1854

J205BMAS IP- 44
16 Amps 3Pin+Earth+Neutral Angled Socket M.R.P. Rs.1719

J205BMAS IP- 67
16 Amps 3Pin+Earth+Neutral Angled Socket M.R.P. Rs.1872

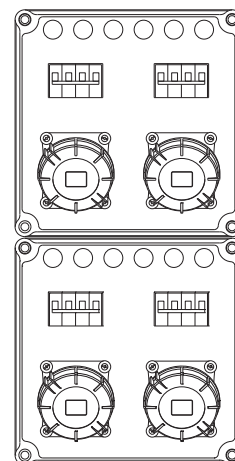

Drawing No. AS044
JEPJB300 - BOX - 2Nos
32 Amps 3Pin+Earth+Neutral Angular Socket IP-67(4 Nos) & Indicator

Provision for 4x4 Pole MCB

Boxes will be Supplied without MCB and Any Other Combinations of Junction Box & Sockets available on request



TELESCOPIC BRUSHES AND BRUSH INSERTS

Sl.No.	CODE NO. FOR BRUSHES	M.R.P. EACH Rs.	Sl.No	SPARES FOR BRUSH PLUG INSERTS	M.R.P. EACH Rs.	
1.	SK4	522	21.	SK-4E	360	
2.	TSK 6/16	540	22.	TSK 6/16E	369	
3.	TSN 6/16	612	23.	TSN 6/16E	422	
4.	TSL 6/16 x 30	630	24.	TSL 6/16 x30E	477	
5.	TSL 6/16 x 40	693	25.	TSL 6/16 x40E	540	
6.	TSL 6/16 x 50	720	26.	TSL 6/16 x50E	585	
7.	TSL 6/16 x 60	774	27.	TSL 6/16 x60E	630	
8.	TSL 6/16 x 70	801	28.	TSL 6/16 x70E	675	
9.	TSL 6/16 x 80	855	29.	TSL 6/16 x80E	729	
10.	TSL 6/16 x 90	891	30.	TSL 6/16 x90E	774	
11.	TSL 6/16 x 100	909	31.	TSL 6/16 x100E	810	
12.	TSN 8	630	32.	TSN 8E	459	
13.	TSL 8 x 30	756	33.	TSL 8 x 30E	522	
14.	TSL 8 x 40	783	34.	TSL 8 x 40E	576	
15.	TSL 8 x 50	810	35.	TSL 8 x 50E	612	
16.	TSL 8 x 60	855	36.	TSL 8 x 60E	648	
17.	TSL 8 x 70	891	37.	TSL 8 x 70E	702	
18.	TSL 8 x 80	909	38.	TSL 8 x 80E	774	
19.	TSL 8 x 90	918	39.	TSL 8 x 90E	810	
20.	TSL 8 x 100	945	40.	TSL 8 x 100E	855	
			41.	TSK Holder	297	
				42.	SK 4 Holder	252
				43.	TSN 6/16 Holder	297
			44.	TSN 8 Holder	306	

CONTACT DETAILS

LAND LINE PHONE NOS.:	044-26251279 044-26257859 044-26254469 044-26254470 044-26257174 044-26255038	E.Mail Id : dchandramohan@jaibalaji.firm.in sales@jaibalaji.in cj@jaibalaji.in av@jaibalaji.in vs@jaibalaji.in
FAX NO.:		
SUPPORT (TECHNICAL & COMMERCIAL) Mr. P. RAMASAMY	MOBILE : 9382862649	WEBSITE : www.jaibalaji.firm.in
SALES Mr. S. ARUNKUMAR Mr. A. VENKATESH	EXTN : 112 EXTN : 123	MOBILE : 9382785527
DESPATCH Mr. K. SREERAM Mr. N. KRISHNAMOORTHY Mr. M. JAGADEESAN	EXTN : 102 EXTN : 118 EXTN : 122	MOBILE : 9382315859 MOBILE : 9382785557 MOBILE : 9176076652

TERMS AND CONDITIONS

Payment - Against Proforma Invoice / COD /VPP/ 100% Documents through Bank

Delivery - Against specific requirement / Depends on Quantity

*** MRP INCLUSIVE OF GST TAX



HOUSE OF INDUSTRIAL AUTOMATION & SWITCHGEAR

AUTOMATION BRAND

SELEC[®]
Creating Best Value

Autonics
(Korea)

OMRON
Industrial Automation

JAIBALAJI

EAPL

sub-zero[®]
Controlled cooling, always

Honeywell
Limit Switch

MW
MEAN WELL

pizzato

salzer[®]
Relays

BTH[™]
Innovations close to you.

CITEL

SWITCHGEAR BRAND

CHINT CHINT
ELECTRIC

C&S TC
electric

SIEMENS
Ingenuity for life

Schneider
Electric